

# Distributed Systems

The second half of *Concurrent and Distributed Systems*  
<https://www.cl.cam.ac.uk/teaching/current/ConcDisSys>

Dr. Martin Kleppmann (mk428@cam)

University of Cambridge

Computer Science Tripos, Part IB



This work is published under a  
Creative Commons BY-SA license.

# A distributed system is...

- ▶ *“... a system in which the failure of a computer you didn't even know existed can render your own computer unusable.”* — Leslie Lamport
- ▶ ... multiple computers communicating via a network...
- ▶ ... trying to achieve some task together
- ▶ Consists of “nodes” (computer, phone, car, robot, ...)

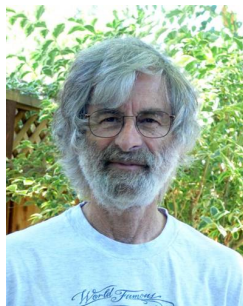

## Recommended reading

- ▶ van Steen & Tanenbaum.  
**“Distributed Systems”**  
(any ed), free ebook available
- ▶ Cachin, Guerraoui & Rodrigues.  
**“Introduction to Reliable and Secure Distributed Programming”** (2nd ed), Springer 2011
- ▶ Kleppmann.  
**“Designing Data-Intensive Applications”**,  
O'Reilly 2017
- ▶ Bacon & Harris.  
**“Operating Systems: Concurrent and Distributed Software Design”**, Addison-Wesley 2003

## Relationships with other courses

- ▶ **Concurrent Systems** – Part IB  
(every distributed system is also concurrent)
- ▶ **Operating Systems** – Part IA  
(inter-process communication, scheduling)
- ▶ **Databases** – Part IA  
(many modern databases are distributed)
- ▶ **Computer Networking** – Part IB Lent term  
(distributed systems involve network communication)
- ▶ **Further Java** – Part IB Michaelmas  
(distributed programming practical exercises)
- ▶ **Security** – Part IB Easter term  
(network protocols with encryption & authentication)
- ▶ **Cloud Computing** – Part II  
(distributed systems for processing large amounts of data)

# Why make a system distributed?

- ▶ **It's inherently distributed:**  
e.g. sending a message from your mobile phone to your friend's phone
- ▶ **For better reliability:**  
even if one node fails, the system as a whole keeps functioning
- ▶ **For better performance:**  
get data from a nearby node rather than one halfway round the world
- ▶ **To solve bigger problems:**  
e.g. huge amounts of data, can't fit on one machine

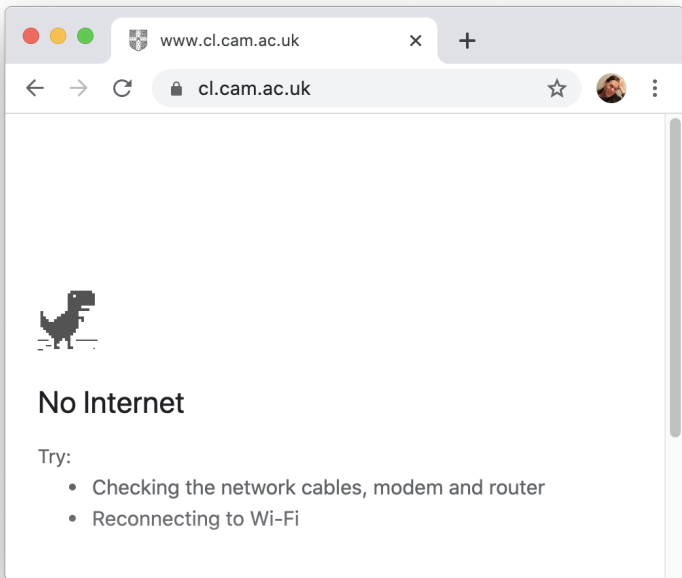

## No Internet

Try:

- Checking the network cables, modem and router
- Reconnecting to Wi-Fi

# Why NOT make a system distributed?

The trouble with distributed systems:

- ▶ Communication may fail (and we might not even know it has failed).
- ▶ Processes may crash (and we might not know).
- ▶ All of this may happen nondeterministically.

**Fault tolerance:** we want the system as a whole to continue working, even when some parts are faulty.

This is hard.

Writing a program to run on a single computer is comparatively easy?!

# Distributed Systems and Computer Networking

We use a simple abstraction of communication:

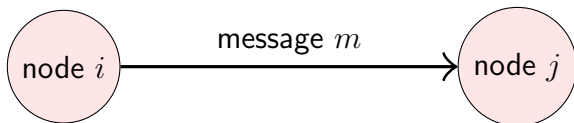

Reality is much more complex:

- ▶ **Various network operators:**  
eduroam, home DSL, cellular data, coffee shop wifi, submarine cable, satellite. . .
- ▶ **Physical communication:**  
electric current, radio waves, laser, hard drives in a van. . .



# Hard drives in a van?!



<https://docs.aws.amazon.com/snowball/latest/ug/using-device.html>

High latency, high bandwidth!

# Latency and bandwidth

**Latency:** time until message arrives

- ▶ In the same building/datacenter:  $\approx 1$  ms
- ▶ One continent to another:  $\approx 100$  ms
- ▶ Hard drives in a van:  $\approx 1$  day

**Bandwidth:** data volume per unit time

- ▶ 3G cellular data:  $\approx 1$  Mbit/s
- ▶ Home broadband:  $\approx 10$  Mbit/s
- ▶ Hard drives in a van: 50 TB/box  $\approx 1$  Gbit/s

(Very rough numbers, vary hugely in practice!)



Study at  
Cambridge

About the  
University

Research at  
Cambridge

Quick links

Search



# Department of Computer Science and Technology

Log in with Raven

Home

The department

Initiatives

Research

Admissions

Current students

Job vacancies

Intranet

## Concurrent and Distributed Systems

**Principal lecturer:** Dr David Greaves  
Martin Kleppmann

**Students:** Part IB CST 50%, Part IB CST 75%

**Course code:** ConcDisSys

**Prerequisite course:** [Object-Oriented Programming](#)  
[Operating Systems](#)

**This course is a prerequisite for:** [Cloud Computing](#)  
[Distributed Ledger Technologies: Foundations and Applications](#)  
[Mobile and Sensor Systems](#)

### Related links

[Course materials](#)

[Information for supervisors](#)

# Client-server example: the web

Time flows from top to bottom.

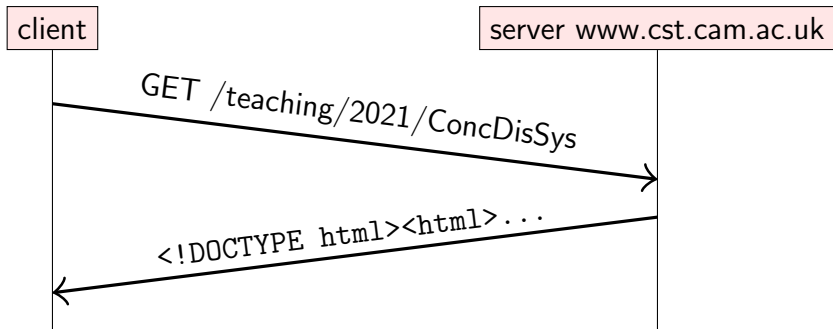

Charles 4.5.6 - Session 1

Structure Sequence

Code	Method	Host	Path	Duration	Size	Sta...	In...
200	GET	www.cst.cam.ac.uk	/teaching/2021/ConcDisSys	111 ms	69.55 KB	Com...	

Filter: www.cst.cam.ac.uk  Focused  Settings

Overview Contents Summary Chart Notes

```

:path /teaching/2021/ConcDisSys
pragma no-cache
cache-control no-cache
upgrade-insecure-requests 1
user-agent Mozilla/5.0 (Macintosh; Intel Mac OS X 10_15_6) AppleWebKit/537.36 (KHTML, like Gecko) Chrome/85.0.4183...
accept text/html,application/xhtml+xml,application/xml;q=0.9,image/avif,image/webp,image/apng,*/*;q=0.8,application/...

```

Headers Cookies Raw

```

1 <!DOCTYPE html>
2
3 <html xmlns="http://www.w3.org/1999/xhtml" lang="en"
4   id="ltr"
5   xmlns:content="http://purl.org/rss/1.0/modules/content/"
6   xmlns:dc="http://purl.org/dc/terms/"
7   xmlns:foaf="http://xmlns.com/foaf/0.1/"
8   xmlns:og="http://ogp.me/ns#"
9   xmlns:rdfs="http://www.w3.org/2000/01/rdf-schema#"
10  xmlns:sioc="http://rdfs.org/sioc/ns#"
11  xmlns:sioct="http://rdfs.org/sioctunes#"

```

Headers Set Cookie Text Hex HTML Raw

GET https://www.cst.cam.ac.uk/profiles/cambridge/themes/cambridge\_theme/favicon.ico

request message

response message

ip.addr == 128.232.132.21

Expression...

No.	Time	Source	Destination	Protocol	Length	Info
2051	5.149927	192.168.1.231	128.232.132.21	TCP	78	59391 → 443 [SYN] Seq=0 Win=6...
2082	5.400527	192.168.1.231	128.232.132.21	TCP	78	59394 → 443 [SYN] Seq=0 Win=6...
2084	5.424557	128.232.132.21	192.168.1.231	TCP	74	443 → 59394 [SYN, ACK] Seq=0 ...
2085	5.424686	192.168.1.231	128.232.132.21	TCP	66	59394 → 443 [ACK] Seq=1 Ack=1...
2086	5.425139	192.168.1.231	128.232.132.21	TLSv1.3	616	Client Hello
2087	5.451977	128.232.132.21	192.168.1.231	TCP	66	443 → 59394 [ACK] Seq=1 Ack=5...
2088	5.451984	128.232.132.21	192.168.1.231	TLSv1.3	165	Hello Retry Request, Change C...
2089	5.452089	192.168.1.231	128.232.132.21	TCP	66	59394 → 443 [ACK] Seq=551 Ack=...
2090	5.452577	192.168.1.231	128.232.132.21	TLSv1.3	650	Change Cipher Spec, Client He...
2091	5.480436	128.232.132.21	192.168.1.231	TLSv1.3	343	Server Hello, Application Dat...
2092	5.480539	192.168.1.231	128.232.132.21	TCP	66	59394 → 443 [ACK] Seq=1135 Ac...
2094	5.490141	192.168.1.231	128.232.132.21	TLSv1.3	140	Application Data
2095	5.490245	192.168.1.231	128.232.132.21	TLSv1.3	158	Application Data

- ▶ Frame 2086: 616 bytes on wire (4928 bits), 616 bytes captured (4928 bits) on interface 0
- ▶ Ethernet II, Src: Apple\_b3:d7:02 (f0:18:98:b3:d7:02), Dst: ZyxelCom\_67:62:90 (8c:59:73:67:62:90)
- ▶ Internet Protocol Version 4, Src: 192.168.1.231, Dst: 128.232.132.21
- ▶ Transmission Control Protocol, Src Port: 59394, Dst Port: 443, Seq: 1, Ack: 1, Len: 550
- ▶ Transport Layer Security

```

0020  84 15 e8 02 01 bb a4 93 59 fd 8d 0c f2 57 80 18  ..Y...W..
0030  08 16 a5 d0 00 00 01 01 08 0a 99 7c 18 f0 6f b5  ..o...|..o.
0040  22 13 16 03 01 02 21 01 00 02 1d 03 03 f2 ad ef  ".!.....
0050  a6 1c bb 45 88 8f 2f 0a 2e 8d 33 5a 02 b8 ed 42  ...E.../.3Z...B
0060  5d d9 f7 46 5b 48 6b 9b ce 94 87 ac 39 20 7b 4e  ]..F[Hk...9 {N
0070  e2 b0 ce 9e ca e6 cd 4c 2b 92 70 4e 38 19 5f e4  ...L + pN8...
0080  30 d7 2e 92 b6 70 90 9e 49 7a 05 17 79 a9 00 20  0...p...Iz...y..
0090  9a 9a 13 01 13 02 13 03 c0 2b c0 2f c0 2c c0 30  ...+.../.0
00a0  cc a9 cc a8 c0 13 c0 14 00 9c 00 9d 00 2f 00 35  .../..5
00b0  01 00 01 b4 fa fa 00 00 00 00 00 16 00 14 00 00  ...
00c0  11 77 77 77 2e 63 73 74 2e 63 61 6d 2e 61 63 2e  .www.cst.cam.ac.

```

# Client-server example: online payments

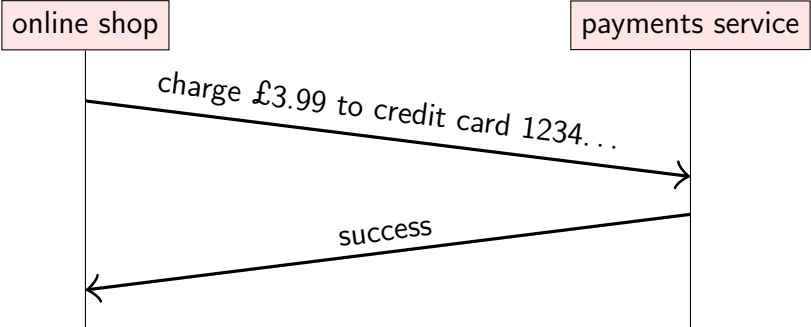

## Remote Procedure Call (RPC) example

```
// Online shop handling customer's card details
```

```
Card card = new Card();  
card.setCardNumber("1234 5678 8765 4321");  
card.setExpiryDate("10/2024");  
card.setCVC("123");
```

```
Result result = paymentsService.processPayment(card,  
    3.99, Currency.GBP);
```

```
if (result.isSuccess()) {  
    fulfilOrder();  
}
```



Implementation of this function is on another node!



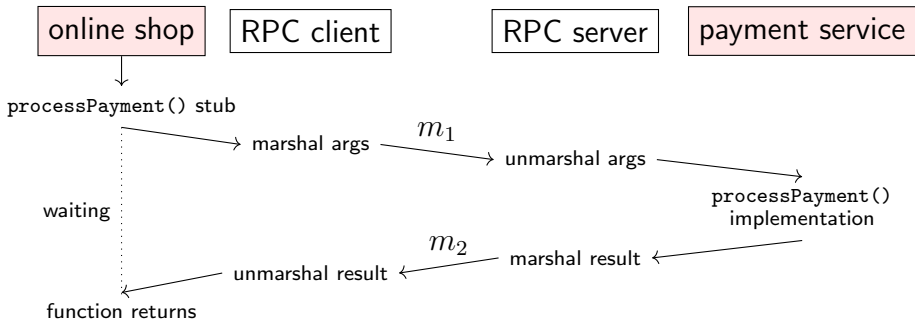

$m_1 =$

```
{
  "request": "processPayment",
  "card": {
    "number": "1234567887654321",
    "expiryDate": "10/2024",
    "CVC": "123"
  },
  "amount": 3.99,
  "currency": "GBP"
}
```

$m_2 =$

```
{
  "result": "success",
  "id": "XP61hHw2Rvo"
}
```

# Remote Procedure Call (RPC)

Ideally, RPC makes a call to a remote function look the same as a local function call.

## **“Location transparency”:**

system hides where a resource is located.

In practice. . .

- ▶ what if the service crashes during the function call?
- ▶ what if a message is lost?
- ▶ what if a message is delayed?
- ▶ if something goes wrong, is it safe to retry?

# RPC history

- ▶ SunRPC/ONC RPC (1980s, basis for NFS)
- ▶ CORBA: object-oriented middleware, hot in the 1990s
- ▶ Microsoft's DCOM and Java RMI (similar to CORBA)
- ▶ SOAP/XML-RPC: RPC using XML and HTTP (1998)
- ▶ Thrift (Facebook, 2007)
- ▶ gRPC (Google, 2015)
- ▶ REST (often with JSON)
- ▶ Ajax in web browsers

## RPC/REST in JavaScript

```
let args = {amount: 3.99, currency: 'GBP', /*...*/};
let request = {
  method: 'POST',
  body:    JSON.stringify(args),
  headers: {'Content-Type': 'application/json'}
};
```

```
fetch('https://example.com/payments', request)
  .then((response) => {
    if (response.ok) success(response.json());
    else failure(response.status); // server error
  })
  .catch((error) => {
    failure(error); // network error
  });
```

# RPC in enterprise systems

“**Service-oriented architecture**” (SOA) / “microservices”:

splitting a large software application into multiple services (on multiple nodes) that communicate via RPC.

Different services implemented in different languages:

- ▶ interoperability: datatype conversions
- ▶ **Interface Definition Language (IDL)**:  
language-independent API specification

# gRPC IDL example

```
message PaymentRequest {
  message Card {
    required string cardNumber = 1;
    optional int32 expiryMonth = 2;
    optional int32 expiryYear = 3;
    optional int32 CVC         = 4;
  }
  enum Currency { GBP = 1; USD = 2; }

  required Card    card    = 1;
  required int64   amount  = 2;
  required Currency currency = 3;
}

message PaymentStatus {
  required bool success = 1;
  optional string errorMessage = 2;
}

service PaymentService {
  rpc ProcessPayment(PaymentRequest) returns (PaymentStatus) {}
}
```

## Lecture 2

# Models of distributed systems

## The two generals problem

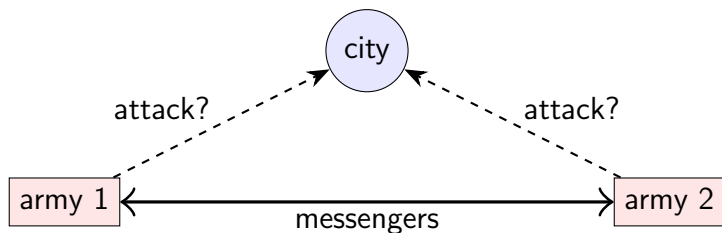

army 1	army 2	outcome
does not attack	does not attack	nothing happens
attacks	does not attack	army 1 defeated
does not attack	attacks	army 2 defeated
attacks	attacks	city captured

**Desired:** army 1 attacks *if and only if* army 2 attacks



# The two generals problem

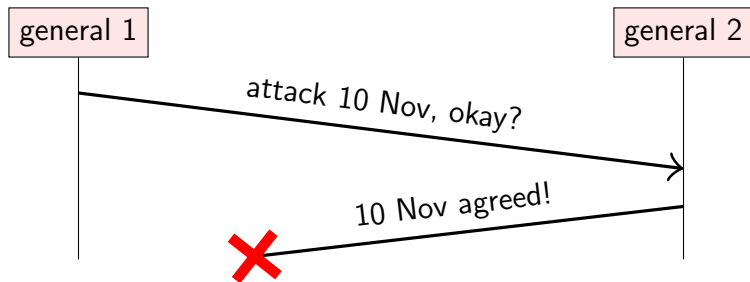

From general 1's point of view, this is indistinguishable from:

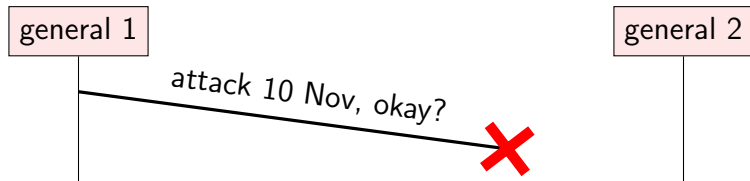

# How should the generals decide?

1. General 1 always attacks, even if no response is received?
  - ▶ Send lots of messengers to increase probability that one will get through
  - ▶ If all are captured, general 2 does not know about the attack, so general 1 loses
2. General 1 only attacks if positive response from general 2 is received?
  - ▶ Now general 1 is safe
  - ▶ But general 2 knows that general 1 will only attack if general 2's response gets through
  - ▶ Now general 2 is in the same situation as general 1 in option 1

**No common knowledge:** the only way of knowing something is to communicate it

## The two generals problem applied

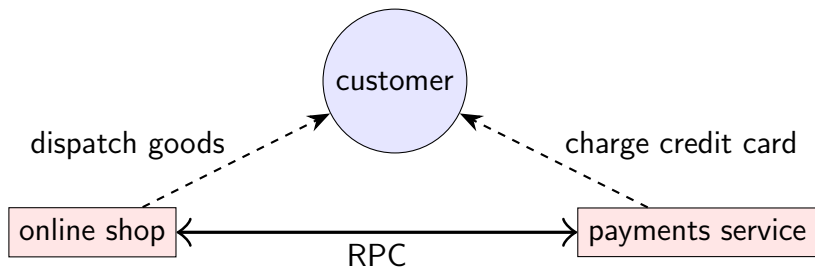

online shop	payments service	outcome
does not dispatch	does not charge	nothing happens
dispatches	does not charge	shop loses money
does not dispatch	charges	customer complaint
dispatches	charges	everyone happy

**Desired:** online shop dispatches *if and only if* payment made

# The Byzantine generals problem

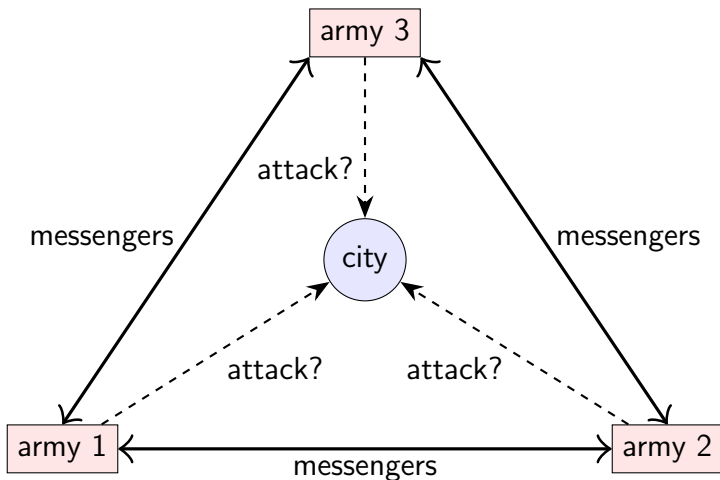

**Problem:** some of the generals might be traitors

# Generals that might lie

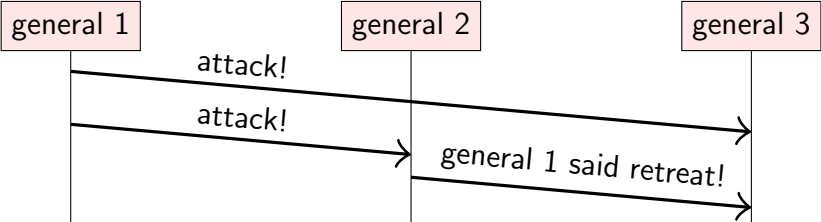

From general 3's point of view, this is indistinguishable from:

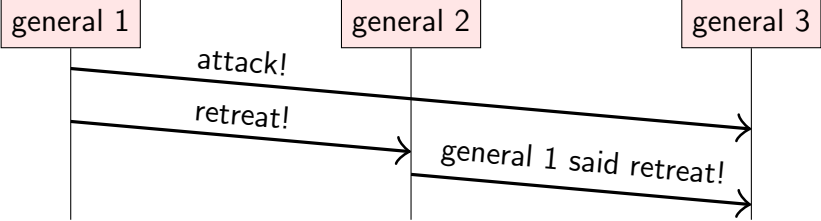

# The Byzantine generals problem

- ▶ Up to  $f$  generals might behave maliciously
- ▶ Honest generals don't know who the malicious ones are
- ▶ The malicious generals may collude
- ▶ Nevertheless, honest generals must agree on plan
  
- ▶ Theorem: need  $3f + 1$  generals in total to tolerate  $f$  malicious generals (i.e.  $< \frac{1}{3}$  may be malicious)
- ▶ Cryptography (digital signatures) helps – but problem remains hard

# Trust relationships and malicious behaviour

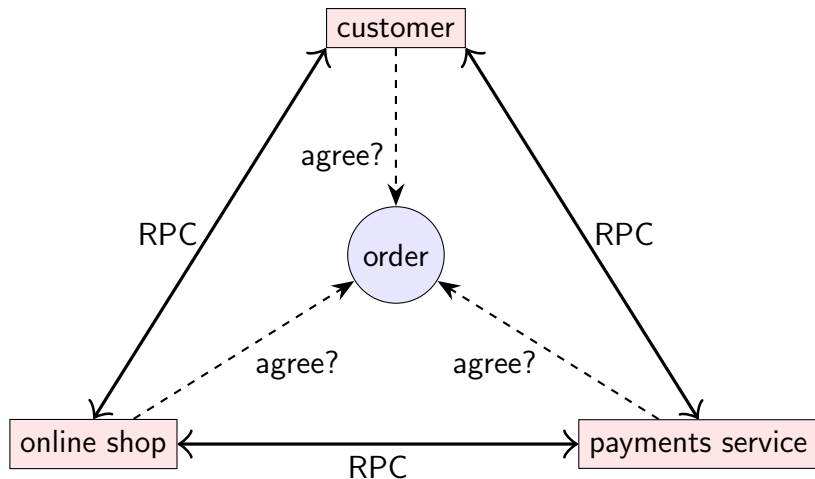

Who can trust whom?

# The Byzantine empire (650 CE)

Byzantium/Constantinople/Istanbul



Source: <https://commons.wikimedia.org/wiki/File:Byzantiumby650AD.svg>

“**Byzantine**” has long been used for “excessively complicated, bureaucratic, devious” (e.g. “*the Byzantine tax law*”)



# System models

We have seen two thought experiments:

- ▶ Two generals problem: a model of networks
- ▶ Byzantine generals problem: a model of node behaviour

In real systems, both nodes and networks may be faulty!

Capture assumptions in a **system model** consisting of:

- ▶ Network behaviour (e.g. message loss)
- ▶ Node behaviour (e.g. crashes)
- ▶ Timing behaviour (e.g. latency)

Choice of models for each of these parts.

# Networks are unreliable



In the sea, sharks bite fibre optic cables

<https://slate.com/technology/2014/08/>

[shark-attacks-threaten-google-s-undersea-internet-cables-video.html](https://slate.com/technology/2014/08/shark-attacks-threaten-google-s-undersea-internet-cables-video.html)

On land, cows step on the cables

<https://twitter.com/uhoelzle/status/1263333283107991558>

# System model: network behaviour

Assume bidirectional **point-to-point** communication between two nodes, with one of:

- ▶ **Reliable** (perfect) links:

A message is received if and only if it is sent.  
Messages may be reordered.

- ▶ **Fair-loss** links:

Messages may be lost, duplicated, or reordered.  
If you keep retrying, a message eventually gets through.

- ▶ **Arbitrary** links (active adversary):

A malicious adversary may interfere with messages  
(eavesdrop, modify, drop, spoof, replay).



retry +  
dedup



TLS

**Network partition:** some links dropping/delaying all messages for extended period of time

# System model: node behaviour

Each node executes a specified algorithm, assuming one of the following:

- ▶ **Crash-stop** (fail-stop):  
A node is faulty if it crashes (at any moment).  
After crashing, it stops executing forever.
- ▶ **Crash-recovery** (fail-recovery):  
A node may crash at any moment, losing its in-memory state. It may resume executing sometime later.
- ▶ **Byzantine** (fail-arbitrary):  
A node is faulty if it deviates from the algorithm.  
Faulty nodes may do anything, including crashing or malicious behaviour.

A node that is not faulty is called “**correct**”

# System model: synchrony (timing) assumptions

Assume one of the following for network and nodes:

- ▶ **Synchronous:**

Message latency no greater than a known upper bound.  
Nodes execute algorithm at a known speed.

- ▶ **Partially synchronous:**

The system is asynchronous for some finite (but unknown) periods of time, synchronous otherwise.

- ▶ **Asynchronous:**

Messages can be delayed arbitrarily.  
Nodes can pause execution arbitrarily.  
No timing guarantees at all.

**Note:** other parts of computer science use the terms “synchronous” and “asynchronous” differently.

# Violations of synchrony in practice

Networks usually have quite predictable latency, which can occasionally increase:

- ▶ Message loss requiring retry
- ▶ Congestion/contention causing queueing
- ▶ Network/route reconfiguration

Nodes usually execute code at a predictable speed, with occasional pauses:

- ▶ Operating system scheduling issues, e.g. priority inversion
- ▶ Stop-the-world garbage collection pauses
- ▶ Page faults, swap, thrashing

Real-time operating systems (RTOS) provide scheduling guarantees, but most distributed systems do not use RTOS

# System models summary

For each of the three parts, pick one:

- ▶ **Network:**  
reliable, fair-loss, or arbitrary
- ▶ **Nodes:**  
crash-stop, crash-recovery, or Byzantine
- ▶ **Timing:**  
synchronous, partially synchronous, or asynchronous

This is the basis for any distributed algorithm.  
If your assumptions are wrong, all bets are off!

# Availability

Online shop wants to sell stuff 24/7!

Service unavailability = downtime = losing money

Availability = uptime = fraction of time that a service is functioning correctly

- ▶ “Two nines” = 99% up = down 3.7 days/year
- ▶ “Three nines” = 99.9% up = down 8.8 hours/year
- ▶ “Four nines” = 99.99% up = down 53 minutes/year
- ▶ “Five nines” = 99.999% up = down 5.3 minutes/year

**Service-Level Objective (SLO):**

e.g. “99.9% of requests in a day get a response in 200 ms”

**Service-Level Agreement (SLA):**

contract specifying some SLO, penalties for violation



# Achieving high availability: fault tolerance

**Failure:** system as a whole isn't working

**Fault:** some part of the system isn't working

- ▶ Node fault: crash (crash-stop/crash-recovery), deviating from algorithm (Byzantine)
- ▶ Network fault: dropping or significantly delaying messages

**Fault tolerance:**

system as a whole continues working, despite faults (some maximum number of faults assumed)

**Single point of failure (SPOF):**

node/network link whose fault leads to failure

# Failure detectors

## **Failure detector:**

algorithm that detects whether another node is faulty

## **Perfect failure detector:**

labels a node as faulty if and only if it has crashed

**Typical implementation** for crash-stop/crash-recovery:  
send message, await response, label node as crashed if no reply within some timeout

## **Problem:**

cannot tell the difference between crashed node, temporarily unresponsive node, lost message, and delayed message

# Failure detection in partially synchronous systems

Perfect timeout-based failure detector exists only in a synchronous crash-stop system with reliable links.

## **Eventually perfect failure detector:**

- ▶ May *temporarily* label a node as crashed, even though it is correct
- ▶ May *temporarily* label a node as correct, even though it has crashed
- ▶ But *eventually*, labels a node as crashed if and only if it has crashed

Reflects fact that detection is not instantaneous, and we may have spurious timeouts

## Lecture 3

# Time, clocks, and ordering of events

## A detective story

In the night from 30 June to 1 July 2012 (UK time), many online services and systems around the world crashed simultaneously.

Servers locked up and stopped responding.

Some airlines could not process any reservations or check-ins for several hours.

What happened?

# Clocks and time in distributed systems

Distributed systems often need to measure time, e.g.:

- ▶ Schedulers, timeouts, failure detectors, retry timers
- ▶ Performance measurements, statistics, profiling
- ▶ Log files & databases: record when an event occurred
- ▶ Data with time-limited validity (e.g. cache entries)
- ▶ Determining order of events across several nodes

We distinguish two types of clock:

- ▶ **physical clocks**: count number of seconds elapsed
- ▶ **logical clocks**: count events, e.g. messages sent

**NB.** Clock in digital electronics (oscillator)

≠ clock in distributed systems (source of **timestamps**)

# Quartz clocks

- ▶ Quartz crystal laser-trimmed to mechanically resonate at a specific frequency
- ▶ Piezoelectric effect: mechanical force  $\Leftrightarrow$  electric field
- ▶ Oscillator circuit produces signal at resonant frequency
- ▶ Count number of cycles to measure elapsed time

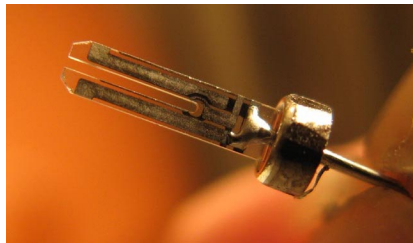

# Quartz clock error: drift

- ▶ One clock runs slightly fast, another slightly slow
- ▶ Drift measured in **parts per million** (ppm)
- ▶  $1 \text{ ppm} = 1 \text{ microsecond/second} = 86 \text{ ms/day} = 32 \text{ s/year}$
- ▶ Most computer clocks correct within  $\approx 50 \text{ ppm}$

Temperature significantly affects drift

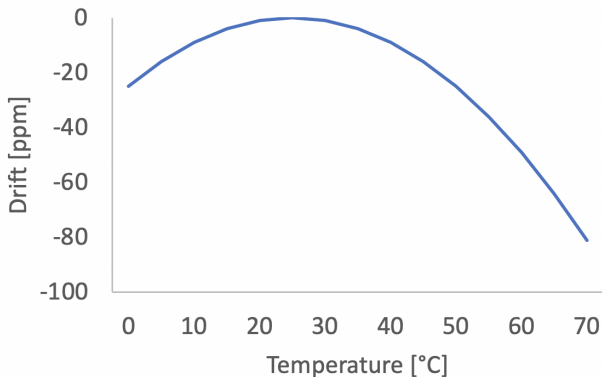



# Atomic clocks

- ▶ Caesium-133 has a resonance (“hyperfine transition”) at  $\approx 9$  GHz
- ▶ Tune an electronic oscillator to that resonant frequency
- ▶ 1 second = 9,192,631,770 periods of that signal
- ▶ Accuracy  $\approx 1$  in  $10^{-14}$  (1 second in 3 million years)
- ▶ Price  $\approx$  £20,000 (?) (can get cheaper rubidium clocks for  $\approx$  £1,000)



<https://www.microsemi.com/product-directory/cesium-frequency-references/4115-5071a-cesium-primary-frequency-standard>

# GPS as time source

- ▶ 31 satellites, each carrying an atomic clock
- ▶ satellite broadcasts current time and location
- ▶ calculate position from speed-of-light delay between satellite and receiver
- ▶ corrections for atmospheric effects, relativity, etc.
- ▶ in datacenters, need antenna on the roof

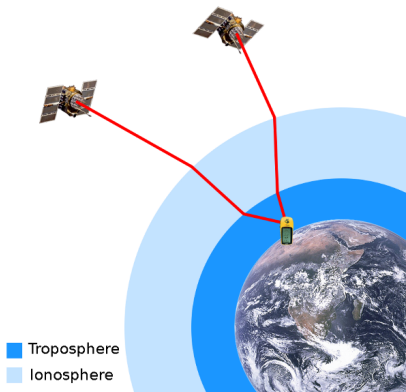

<https://commons.wikimedia.org/wiki/File:Gps-atmospheric-effects.png>

# Coordinated Universal Time (UTC)

**Greenwich Mean Time** (GMT, solar time): it's noon when the sun is in the south, as seen from the Greenwich meridian

**International Atomic Time** (TAI): 1 day is  $24 \times 60 \times 60 \times 9,192,631,770$  periods of caesium-133's resonant frequency

**Problem:** speed of Earth's rotation is not constant

**Compromise:** UTC is TAI with corrections to account for Earth rotation

**Time zones** and **daylight savings time** are offsets to UTC



# Leap seconds

Every year, on 30 June and 31 December at 23:59:59 UTC, one of three things happens:

- ▶ The clock immediately jumps forward to 00:00:00, skipping one second (**negative leap second**)
- ▶ The clock moves to 00:00:00 after one second, as usual
- ▶ The clock moves to 23:59:60 after one second, and then moves to 00:00:00 after one further second (**positive leap second**)

This is announced several months beforehand.



<http://leapsecond.com/notes/leap-watch.htm>

# How computers represent timestamps

Two most common representations:

- ▶ **Unix time:** number of seconds since 1 January 1970 00:00:00 UTC (the “epoch”), *not counting leap seconds*
- ▶ **ISO 8601:** year, month, day, hour, minute, second, and timezone offset relative to UTC  
example: 2020-11-09T09:50:17+00:00

Conversion between the two requires:

- ▶ Gregorian calendar: 365 days in a year, except leap years  
(`year % 4 == 0 && (year % 100 != 0 || year % 400 == 0)`)
- ▶ Knowledge of past and future leap seconds...?!

# How most software deals with leap seconds

## By ignoring them!

However, OS and DistSys often need timings with sub-second accuracy.

30 June 2012: bug in Linux kernel caused livelock on leap second, causing many Internet services to go down

Pragmatic solution: “**smear**” (spread out) the leap second over the course of a day



[https://www.flickr.com/photos/ru\\_boff/37915499055/](https://www.flickr.com/photos/ru_boff/37915499055/)

# Clock synchronisation

Computers track physical time/UTC with a quartz clock (with battery, continues running when power is off)

Due to **clock drift**, clock error gradually increases

**Clock skew**: difference between two clocks at a point in time

**Solution**: Periodically get the current time from a server that has a more accurate time source (atomic clock or GPS receiver)

Protocols: Network Time Protocol (**NTP**),  
Precision Time Protocol (**PTP**)

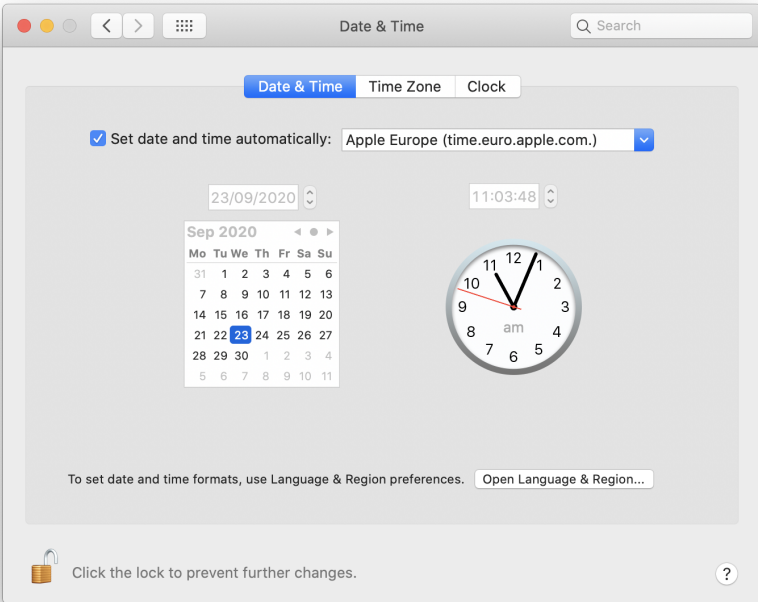



# Network Time Protocol (NTP)

Many operating system vendors run NTP servers, configure OS to use them by default

Hierarchy of clock servers arranged into **strata**:

- ▶ Stratum 0: atomic clock or GPS receiver
- ▶ Stratum 1: synced directly with stratum 0 device
- ▶ Stratum 2: servers that sync with stratum 1, etc.

May contact multiple servers, discard outliers, average rest

Makes multiple requests to the same server, use statistics to reduce random error due to variations in network latency

Reduces clock skew to a few milliseconds in good network conditions, but can be much worse!

# Estimating time over a network

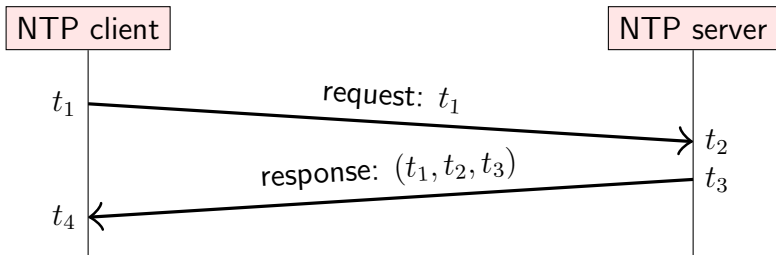

Round-trip network delay:  $\delta = (t_4 - t_1) - (t_3 - t_2)$

Estimated server time when client receives response:  $t_3 + \frac{\delta}{2}$

Estimated clock skew:  $\theta = t_3 + \frac{\delta}{2} - t_4 = \frac{t_2 - t_1 + t_3 - t_4}{2}$

## Correcting clock skew

Once the client has estimated the clock skew  $\theta$ , it needs to apply that correction to its clock.

- ▶ If  $|\theta| < 125$  ms, **slew** the clock:  
slightly speed it up or slow it down by up to 500 ppm  
(brings clocks in sync within  $\approx 5$  minutes)
- ▶ If  $125$  ms  $\leq |\theta| < 1,000$  s, **step** the clock:  
suddenly reset client clock to estimated server timestamp
- ▶ If  $|\theta| \geq 1,000$  s, **panic** and do nothing  
(leave the problem for a human operator to resolve)

Systems that rely on clock sync need to monitor clock skew!

Initial run of NTP 3.5f on HP L2000-44/2

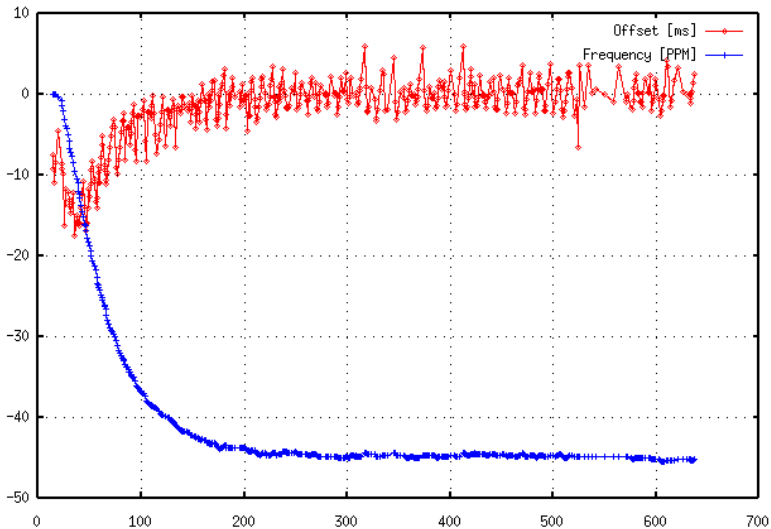

<http://www.ntp.org/ntpfaq/NTP-s-algo.htm>

## Monotonic and time-of-day clocks

```
// BAD:  
long startTime = System.currentTimeMillis();  
doSomething();  
long endTime = System.currentTimeMillis();  
long elapsedMillis = endTime - startTime;  
// elapsedMillis may be negative!
```

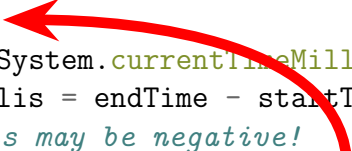

NTP client steps the clock during this

```
// GOOD:  
long startTime = System.nanoTime();  
doSomething();  
long endTime = System.nanoTime();  
long elapsedNanos = endTime - startTime;  
// elapsedNanos is always >= 0
```

# Monotonic and time-of-day clocks

## Time-of-day clock:

- ▶ Time since a fixed date (e.g. 1 January 1970 epoch)
- ▶ May suddenly move forwards or backwards (NTP stepping), subject to leap second adjustments
- ▶ Timestamps can be compared across nodes (if synced)
- ▶ Java: `System.currentTimeMillis()`
- ▶ Linux: `clock_gettime(CLOCK_REALTIME)`

## Monotonic clock:

- ▶ Time since arbitrary point (e.g. when machine booted up)
- ▶ Always moves forwards at near-constant rate
- ▶ Good for measuring elapsed time on a single node
- ▶ Java: `System.nanoTime()`
- ▶ Linux: `clock_gettime(CLOCK_MONOTONIC)`

## Ordering of messages

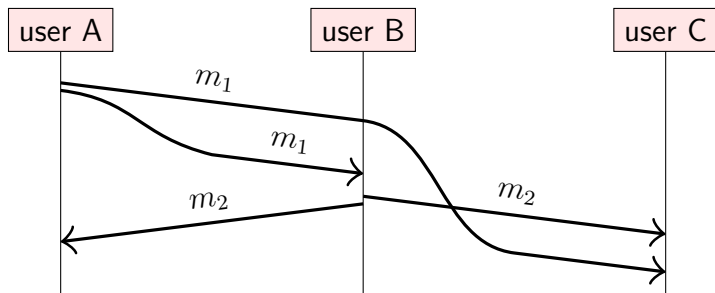

$m_1$  = "A says: The moon is made of cheese!"

$m_2$  = "B says: Oh no it isn't!"

C sees  $m_2$  first,  $m_1$  second,  
even though logically  $m_1$  **happened before**  $m_2$ .

# Physical timestamps inconsistent with causality

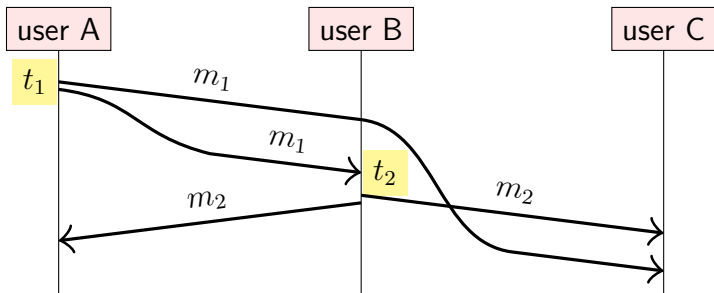

$m_1 = (t_1, \text{"A says: The moon is made of cheese!"})$

$m_2 = (t_2, \text{"B says: Oh no it isn't!"})$

**Problem:** even with synced clocks,  $t_2 < t_1$  is possible.  
Timestamp order is inconsistent with expected order!



# The happens-before relation

An **event** is something happening at one node (sending or receiving a message, or a local execution step).

We say event  $a$  **happens before** event  $b$  (written  $a \rightarrow b$ ) iff:

- ▶  $a$  and  $b$  occurred at the same node, and  $a$  occurred before  $b$  in that node's local execution order; or
- ▶ event  $a$  is the sending of some message  $m$ , and event  $b$  is the receipt of that same message  $m$  (assuming sent messages are unique); or
- ▶ there exists an event  $c$  such that  $a \rightarrow c$  and  $c \rightarrow b$ .

The happens-before relation is a partial order: it is possible that neither  $a \rightarrow b$  nor  $b \rightarrow a$ . In that case,  $a$  and  $b$  are **concurrent** (written  $a \parallel b$ ).

## Happens-before relation example

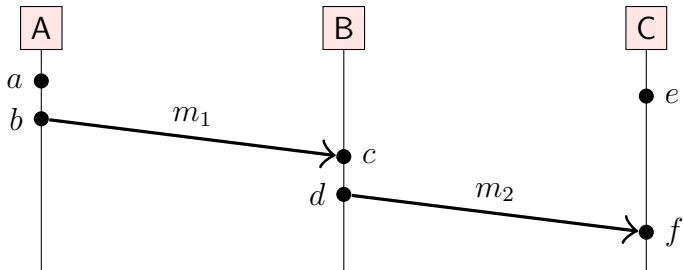

- ▶  $a \rightarrow b$ ,  $c \rightarrow d$ , and  $e \rightarrow f$  due to node execution order
- ▶  $b \rightarrow c$  and  $d \rightarrow f$  due to messages  $m_1$  and  $m_2$
- ▶  $a \rightarrow c$ ,  $a \rightarrow d$ ,  $a \rightarrow f$ ,  $b \rightarrow d$ ,  $b \rightarrow f$ , and  $c \rightarrow f$  due to transitivity
- ▶  $a \parallel e$ ,  $b \parallel e$ ,  $c \parallel e$ , and  $d \parallel e$

# Causality

Taken from physics (relativity).

- ▶ When  $a \rightarrow b$ , then  $a$  **might have caused**  $b$ .
- ▶ When  $a \parallel b$ , we know that  $a$  **cannot have caused**  $b$ .

Happens-before relation encodes **potential causality**.

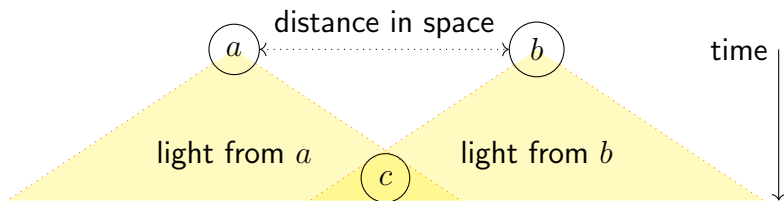

Let  $\prec$  be a strict total order on events.

If  $(a \rightarrow b) \implies (a \prec b)$  then  $\prec$  is a **causal order**  
(or:  $\prec$  is "consistent with causality").

NB. "causal"  $\neq$  "casual"!

## Lecture 4

# Broadcast protocols and logical time

# Physical timestamps inconsistent with causality

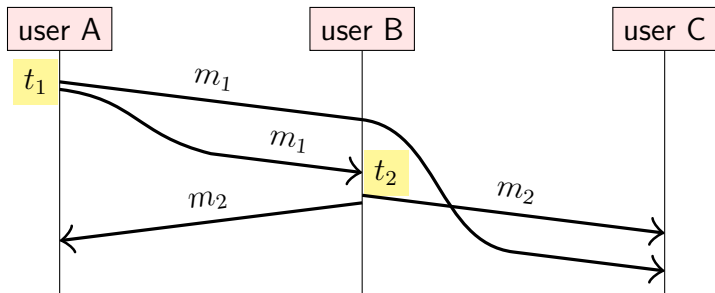

$m_1 = (t_1, \text{"A says: The moon is made of cheese!"})$

$m_2 = (t_2, \text{"B says: Oh no it isn't!"})$

**Problem:** even with synced clocks,  $t_2 < t_1$  is possible.  
Timestamp order is inconsistent with expected order!

## Logical vs. physical clocks

- ▶ Physical clock: count number of **seconds elapsed**
- ▶ Logical clock: count number of **events occurred**

Physical timestamps: useful for many things, but may be **inconsistent with causality**.

Logical clocks: designed to **capture causal dependencies**.

$$(e_1 \rightarrow e_2) \implies (T(e_1) < T(e_2))$$

We will look at two types of logical clocks:

- ▶ Lamport clocks
- ▶ Vector clocks

# Lamport clocks algorithm

**on** initialisation **do**

$t := 0$                       ▷ each node has its own local variable  $t$

**end on**

**on** any event occurring at the local node **do**

$t := t + 1$

**end on**

**on** request to send message  $m$  **do**

$t := t + 1$ ; send  $(t, m)$  via the underlying network link

**end on**

**on** receiving  $(t', m)$  via the underlying network link **do**

$t := \max(t, t') + 1$

deliver  $m$  to the application

**end on**

## Lamport clocks in words

- ▶ Each node maintains a counter  $t$ , incremented on every local event  $e$
- ▶ Let  $L(e)$  be the value of  $t$  after that increment
- ▶ Attach current  $t$  to messages sent over network
- ▶ Recipient moves its clock forward to timestamp in the message (if greater than local counter), then increments

Properties of this scheme:

- ▶ If  $a \rightarrow b$  then  $L(a) < L(b)$
- ▶ However,  $L(a) < L(b)$  does not imply  $a \rightarrow b$
- ▶ Possible that  $L(a) = L(b)$  for  $a \neq b$



## Lamport clocks example

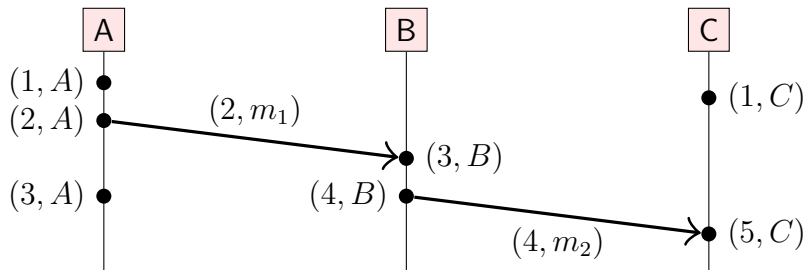

Let  $N(e)$  be the node at which event  $e$  occurred.  
Then the pair  $(L(e), N(e))$  **uniquely identifies** event  $e$ .

Define a **total order**  $\prec$  using Lamport timestamps:

$$(a \prec b) \iff (L(a) < L(b) \vee (L(a) = L(b) \wedge N(a) < N(b)))$$

This order is **causal**:  $(a \rightarrow b) \implies (a \prec b)$

## Vector clocks

Given Lamport timestamps  $L(a)$  and  $L(b)$  with  $L(a) < L(b)$  we can't tell whether  $a \rightarrow b$  or  $a \parallel b$ .

If we want to detect which events are concurrent, we need **vector clocks**:

- ▶ Assume  $n$  nodes in the system,  $N = \langle N_1, N_2, \dots, N_n \rangle$
- ▶ Vector timestamp of event  $a$  is  $V(a) = \langle t_1, t_2, \dots, t_n \rangle$
- ▶  $t_i$  is number of events observed by node  $N_i$
- ▶ Each node has a current vector timestamp  $T$
- ▶ On event at node  $N_i$ , increment vector element  $T[i]$
- ▶ Attach current vector timestamp to each message
- ▶ Recipient merges message vector into its local vector

## Vector clocks algorithm

**on** initialisation at node  $N_i$  **do**

$T := \langle 0, 0, \dots, 0 \rangle$  ▷ local variable at node  $N_i$

**end on**

**on** any event occurring at node  $N_i$  **do**

$T[i] := T[i] + 1$

**end on**

**on** request to send message  $m$  at node  $N_i$  **do**

$T[i] := T[i] + 1$ ; send  $(T, m)$  via network

**end on**

**on** receiving  $(T', m)$  at node  $N_i$  via the network **do**

$T[j] := \max(T[j], T'[j])$  for every  $j \in \{1, \dots, n\}$

$T[i] := T[i] + 1$ ; deliver  $m$  to the application

**end on**

## Vector clocks example

Assuming the vector of nodes is  $N = \langle A, B, C \rangle$ :

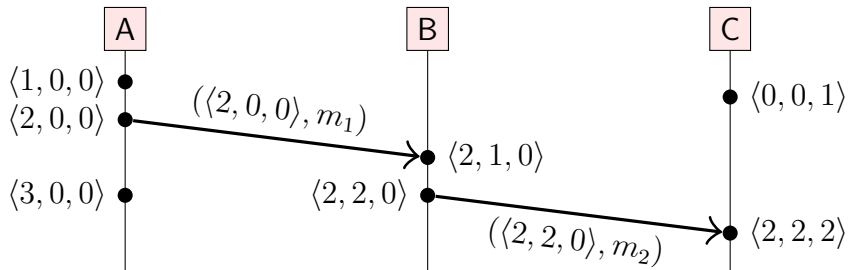

The vector timestamp of an event  $e$  represents a set of events,  $e$  and its causal dependencies:  $\{e\} \cup \{a \mid a \rightarrow e\}$

For example,  $\langle 2, 2, 0 \rangle$  represents the first two events from A, the first two events from B, and no events from C.

## Vector clocks ordering

Define the following order on vector timestamps  
(in a system with  $n$  nodes):

- ▶  $T = T'$  iff  $T[i] = T'[i]$  for all  $i \in \{1, \dots, n\}$
- ▶  $T \leq T'$  iff  $T[i] \leq T'[i]$  for all  $i \in \{1, \dots, n\}$
- ▶  $T < T'$  iff  $T \leq T'$  and  $T \neq T'$
- ▶  $T \parallel T'$  iff  $T \not\leq T'$  and  $T' \not\leq T$

$$V(a) \leq V(b) \text{ iff } (\{a\} \cup \{e \mid e \rightarrow a\}) \subseteq (\{b\} \cup \{e \mid e \rightarrow b\})$$

Properties of this order:

- ▶  $(V(a) < V(b)) \iff (a \rightarrow b)$
- ▶  $(V(a) = V(b)) \iff (a = b)$
- ▶  $(V(a) \parallel V(b)) \iff (a \parallel b)$

# Broadcast protocols

Broadcast (multicast) is **group communication**:

- ▶ One node sends message, all nodes in group deliver it
- ▶ Set of group members may be fixed (static) or dynamic
- ▶ If one node is faulty, remaining group members carry on
- ▶ Note: concept is more general than IP multicast  
(we build upon point-to-point messaging)

Build upon system models from lecture 2:

- ▶ Can be **best-effort** (may drop messages) or **reliable** (non-faulty nodes deliver every message, by retransmitting dropped messages)
- ▶ Asynchronous/partially synchronous timing model  
⇒ **no upper bound** on message latency

# Receiving versus delivering

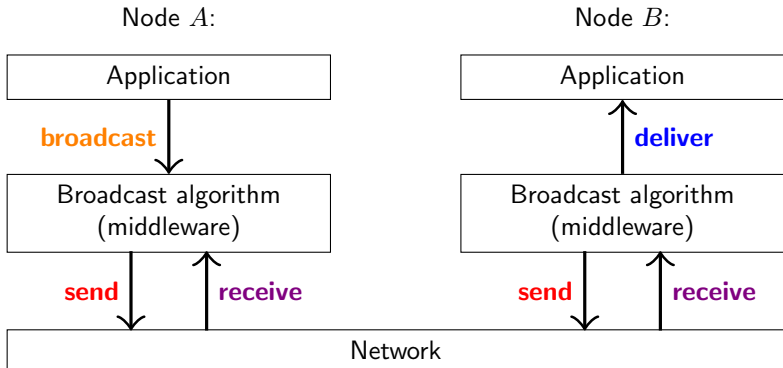

Assume network provides point-to-point **send/receive**

After broadcast algorithm **receives** message from network, it may buffer/queue it before **delivering** to the application

# Forms of reliable broadcast

## **FIFO broadcast:**

If  $m_1$  and  $m_2$  are broadcast by the same node, and  $\text{broadcast}(m_1) \rightarrow \text{broadcast}(m_2)$ , then  $m_1$  must be delivered before  $m_2$

## **Causal broadcast:**

If  $\text{broadcast}(m_1) \rightarrow \text{broadcast}(m_2)$  then  $m_1$  must be delivered before  $m_2$

## **Total order broadcast:**

If  $m_1$  is delivered before  $m_2$  on one node, then  $m_1$  must be delivered before  $m_2$  on all nodes

## **FIFO-total order broadcast:**

Combination of FIFO broadcast and total order broadcast



# FIFO broadcast

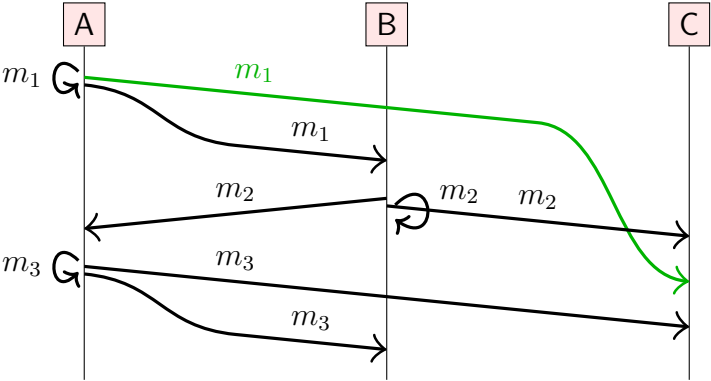

Messages sent by the same node must be delivered in the order they were sent.

Messages sent by different nodes can be delivered in any order.

Valid orders:  $(m_2, m_1, m_3)$  or  $(m_1, m_2, m_3)$  or  $(m_1, m_3, m_2)$

## Causal broadcast

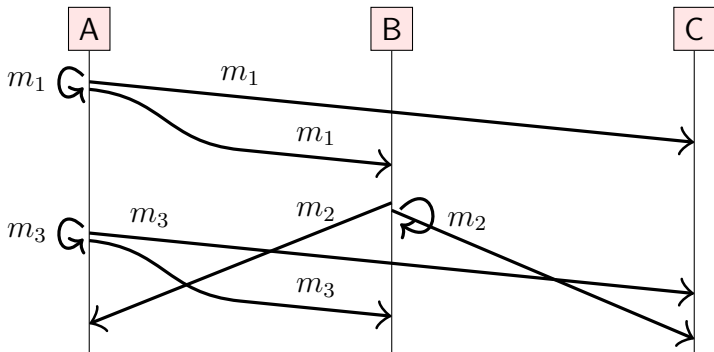

Causally related messages must be delivered in causal order.  
Concurrent messages can be delivered in any order.

Here:  $\text{broadcast}(m_1) \rightarrow \text{broadcast}(m_2)$  and  
 $\text{broadcast}(m_1) \rightarrow \text{broadcast}(m_3)$

$\implies$  valid orders are:  $(m_1, m_2, m_3)$  or  $(m_1, m_3, m_2)$

## Total order broadcast (1)

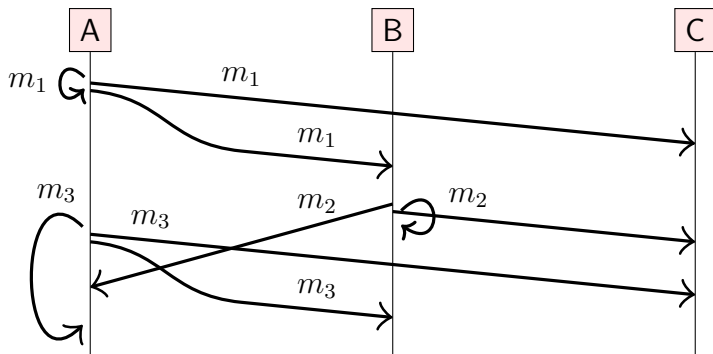

All nodes must deliver messages in **the same** order  
(here:  $m_1, m_2, m_3$ )

This includes a node's deliveries to itself!

## Total order broadcast (2)

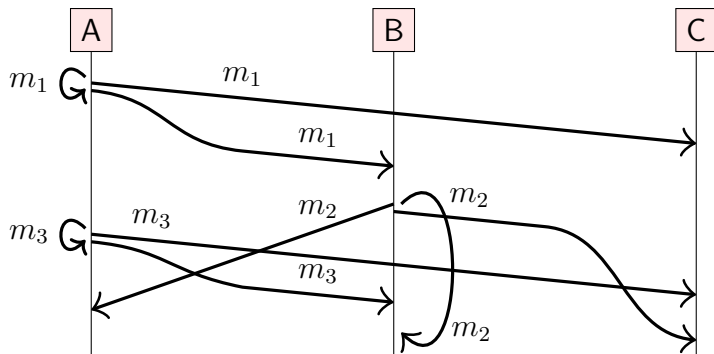

All nodes must deliver messages in **the same** order  
(here:  $m_1, m_3, m_2$ )

This includes a node's deliveries to itself!

# Relationships between broadcast models

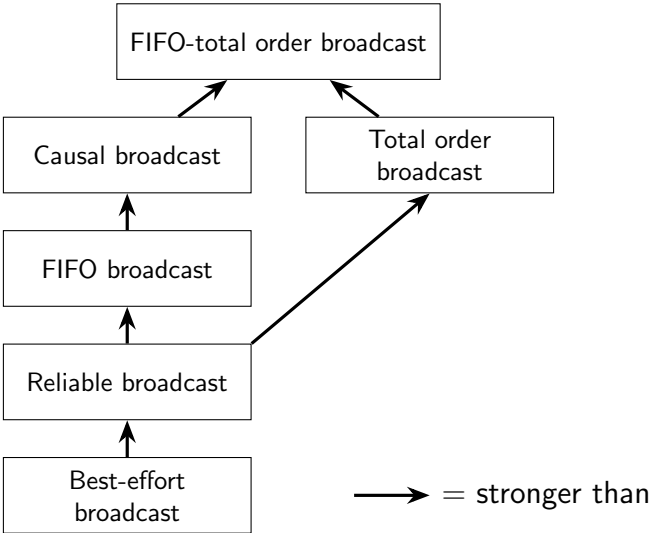

# Broadcast algorithms

Break down into two layers:

1. Make best-effort broadcast reliable by retransmitting dropped messages
2. Enforce delivery order on top of reliable broadcast

First attempt: **broadcasting node sends message directly** to every other node

- ▶ Use reliable links (retry + deduplicate)
- ▶ Problem: node may crash before all messages delivered

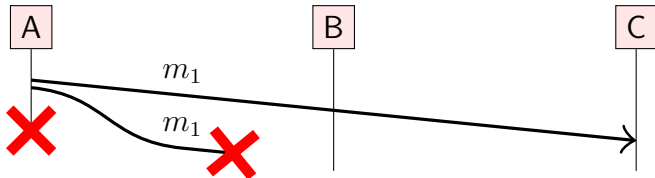

## Eager reliable broadcast

Idea: the **first time** a node receives a particular message, it **re-broadcasts** to each other node (via reliable links).

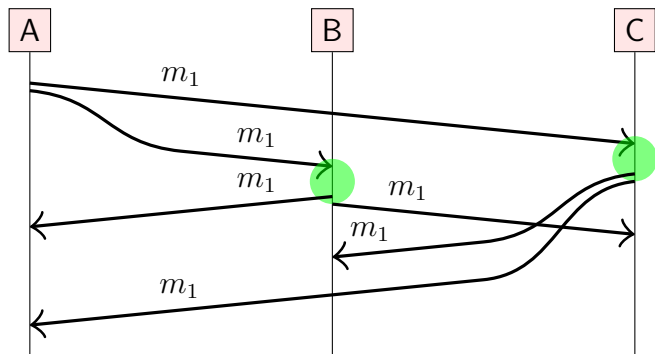

Reliable, but... up to  $O(n^2)$  messages for  $n$  nodes!

# Gossip protocols

Useful when broadcasting to a large number of nodes.  
Idea: when a node receives a message for the first time,  
**forward it to 3 other nodes**, chosen randomly.

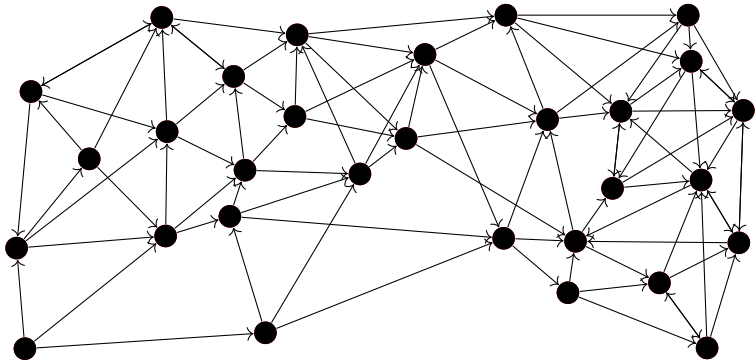

Eventually reaches all nodes (with high probability).



# FIFO broadcast algorithm

**on** initialisation **do**

$sendSeq := 0$ ;  $delivered := \langle 0, 0, \dots, 0 \rangle$ ;  $buffer := \{\}$

**end on**

**on** request to broadcast  $m$  at node  $N_i$  **do**

send  $(i, sendSeq, m)$  via reliable broadcast

$sendSeq := sendSeq + 1$

**end on**

**on** receiving  $msg$  from reliable broadcast at node  $N_i$  **do**

$buffer := buffer \cup \{msg\}$

**while**  $\exists sender, m. (sender, delivered[sender], m) \in buffer$  **do**

deliver  $m$  to the application

$delivered[sender] := delivered[sender] + 1$

**end while**

**end on**

# Causal broadcast algorithm

**on** initialisation **do**

$sendSeq := 0$ ;  $delivered := \langle 0, 0, \dots, 0 \rangle$ ;  $buffer := \{\}$

**end on**

**on** request to broadcast  $m$  at node  $N_i$  **do**

$deps := delivered$ ;  $deps[i] := sendSeq$

send  $(i, deps, m)$  via reliable broadcast

$sendSeq := sendSeq + 1$

**end on**

**on** receiving  $msg$  from reliable broadcast at node  $N_i$  **do**

$buffer := buffer \cup \{msg\}$

**while**  $\exists (sender, deps, m) \in buffer. deps \leq delivered$  **do**

deliver  $m$  to the application

$buffer := buffer \setminus \{(sender, deps, m)\}$

$delivered[sender] := delivered[sender] + 1$

**end while**

**end on**

## Vector clocks ordering

Define the following order on vector timestamps  
(in a system with  $n$  nodes):

- ▶  $T = T'$  iff  $T[i] = T'[i]$  for all  $i \in \{1, \dots, n\}$
- ▶  $T \leq T'$  iff  $T[i] \leq T'[i]$  for all  $i \in \{1, \dots, n\}$
- ▶  $T < T'$  iff  $T \leq T'$  and  $T \neq T'$
- ▶  $T \parallel T'$  iff  $T \not\leq T'$  and  $T' \not\leq T$

$$V(a) \leq V(b) \text{ iff } (\{a\} \cup \{e \mid e \rightarrow a\}) \subseteq (\{b\} \cup \{e \mid e \rightarrow b\})$$

Properties of this order:

- ▶  $(V(a) < V(b)) \iff (a \rightarrow b)$
- ▶  $(V(a) = V(b)) \iff (a = b)$
- ▶  $(V(a) \parallel V(b)) \iff (a \parallel b)$

# Total order broadcast algorithms

## **Single leader** approach:

- ▶ One node is designated as leader (sequencer)
- ▶ To broadcast message, send it to the leader; leader broadcasts it via FIFO broadcast.
- ▶ Problem: leader crashes  $\implies$  no more messages delivered
- ▶ Changing the leader safely is difficult

## **Lamport clocks** approach:

- ▶ Attach Lamport timestamp to every message
- ▶ Deliver messages in total order of timestamps
- ▶ Problem: how do you know if you have seen all messages with timestamp  $< T$ ? Need to use FIFO links and wait for message with timestamp  $\geq T$  from *every* node

Lecture 5

# Replication

# Replication

- ▶ Keeping a copy of the same data on multiple nodes
- ▶ Databases, filesystems, caches, ...
- ▶ A node that has a copy of the data is called a **replica**
- ▶ If some replicas are faulty, others are still accessible
- ▶ Spread load across many replicas
- ▶ Easy if the data doesn't change: just copy it
- ▶ We will focus on data changes

Compare to **RAID** (Redundant Array of Independent Disks):  
replication within a single computer

- ▶ RAID has single controller; in distributed system, each node acts independently
- ▶ Replicas can be distributed around the world, near users

## Retrying state updates

**User A:** The moon is not actually made of cheese!

 Like 12,300 people like this.

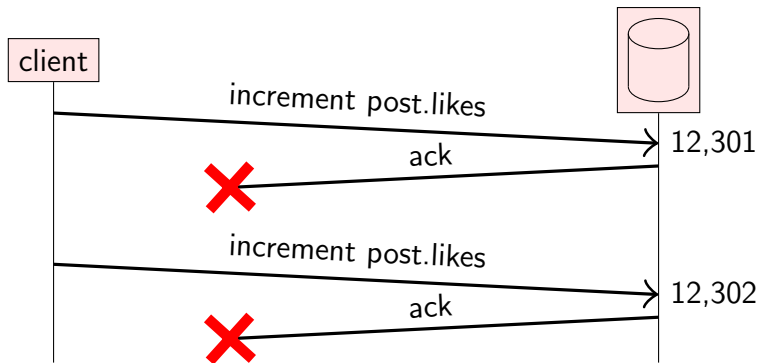

Deduplicating requests requires that the database tracks which requests it has already seen (in stable storage)



TWEETS  
**6,219**

FOLLOWING  
**-20**

FOLLOWERS  
**24.1K**



 **Follow**

# Лепра

@lepratorium

 Добро пожаловать отсюда

Default City



**Лепра** @lepratorium · 2h

Викторианские советы

Часть 2 [pic.twitter.com/21PraRYBaO](https://pic.twitter.com/21PraRYBaO)

Details



**Лепра** @lepratorium · 2h

Викторианские советы

Часть 1 [pic.twitter.com/BVE6ao8711](https://pic.twitter.com/BVE6ao8711)

Details

[Go to full profile](#)



# Idempotence

A function  $f$  is idempotent if  $f(x) = f(f(x))$ .

- ▶ **Not idempotent:**  $f(\text{likeCount}) = \text{likeCount} + 1$
- ▶ **Idempotent:**  $f(\text{likeSet}) = \text{likeSet} \cup \{\text{userID}\}$

Idempotent requests can be retried without deduplication.

Choice of retry behaviour:

- ▶ **At-most-once** semantics:  
send request, don't retry, update may not happen
- ▶ **At-least-once** semantics:  
retry request until acknowledged, may repeat update
- ▶ **Exactly-once** semantics:  
retry + idempotence or deduplication

## Adding and then removing again

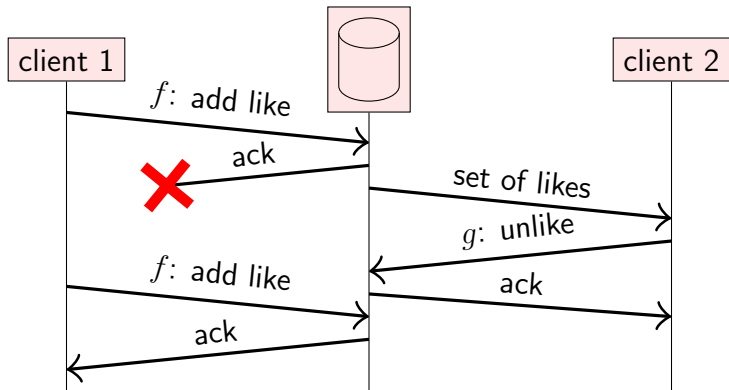

$$f(\text{likes}) = \text{likes} \cup \{\text{userID}\}$$

$$g(\text{likes}) = \text{likes} \setminus \{\text{userID}\}$$

**Idempotent?**  $f(f(x)) = f(x)$  but  $f(g(f(x))) \neq g(f(x))$

## Another problem with adding and removing

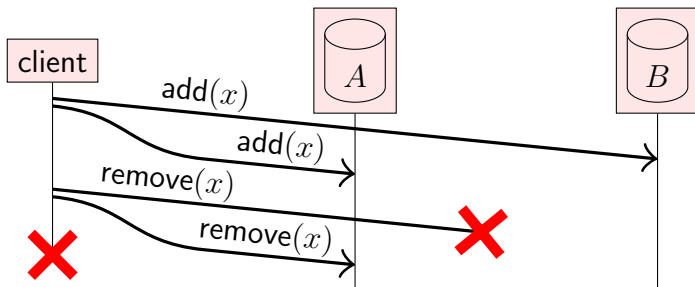

Final state ( $x \notin A$ ,  $x \in B$ ) is the same as in this case:

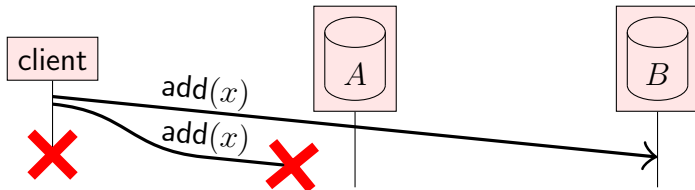

# Timestamps and tombstones

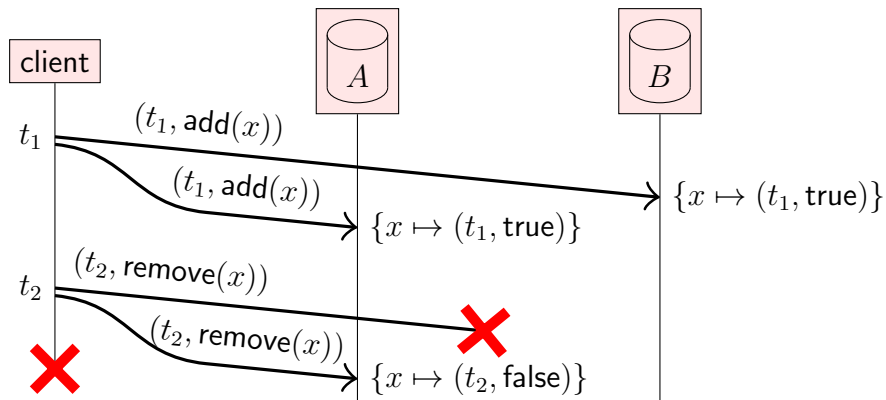

“remove( $x$ )” doesn’t actually remove  $x$ : it labels  $x$  with “false” to indicate it is invisible (a **tombstone**)

Every record has **logical timestamp** of last write

## Reconciling replicas

Replicas periodically communicate among themselves to check for any inconsistencies.

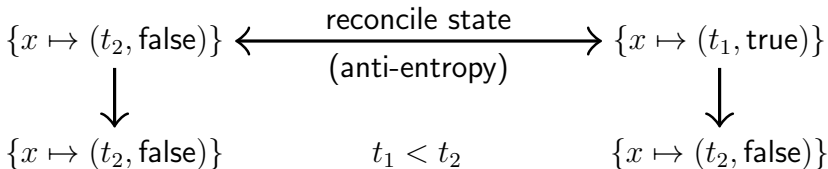
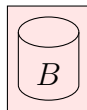
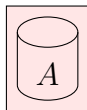

Propagate the record with the latest timestamp,  
discard the records with earlier timestamps  
(for a given key).

## Concurrent writes by different clients

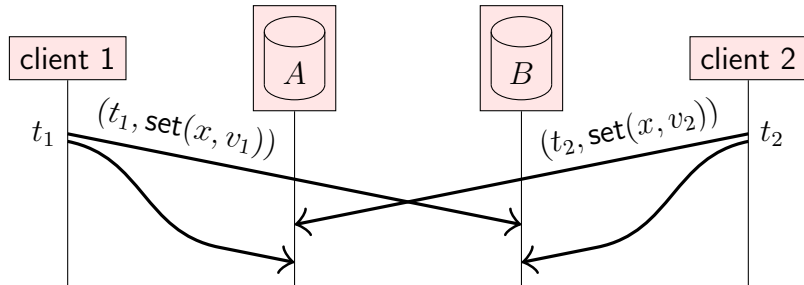

Two common approaches:

- ▶ **Last writer wins (LWW):**

Use timestamps with total order (e.g. Lamport clock)  
Keep  $v_2$  and discard  $v_1$  if  $t_2 > t_1$ . Note: **data loss!**

- ▶ **Multi-value register:**

Use timestamps with partial order (e.g. vector clock)  
 $v_2$  replaces  $v_1$  if  $t_2 > t_1$ ; preserve both  $\{v_1, v_2\}$  if  $t_1 \parallel t_2$

## Probability of faults

A replica may be **unavailable** due to network partition or node fault (e.g. crash, hardware problem).

Assume each replica has probability  $p$  of being faulty or unavailable at any one time, and that faults are independent. (Not actually true! But okay approximation for now.)

Probability of **all**  $n$  replicas being faulty:  $p^n$

Probability of  $\geq 1$  out of  $n$  replicas being faulty:  $1 - (1 - p)^n$

Example with  $p = 0.01$ :

replicas $n$	$P(\geq 1 \text{ faulty})$	$P(\geq \frac{n+1}{2} \text{ faulty})$	$P(\text{all } n \text{ faulty})$
1	0.01	0.01	0.01
3	0.03	$3 \cdot 10^{-4}$	$10^{-6}$
5	0.049	$1 \cdot 10^{-5}$	$10^{-10}$
100	0.63	$6 \cdot 10^{-74}$	$10^{-200}$

## Read-after-write consistency

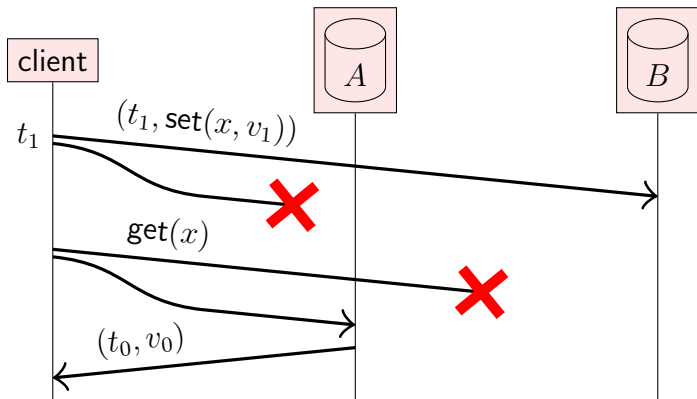

Writing to one replica, reading from another: client does not read back the value it has written

Require writing to/reading from both replicas  $\implies$  cannot write/read if one replica is unavailable



## Quorum (2 out of 3)

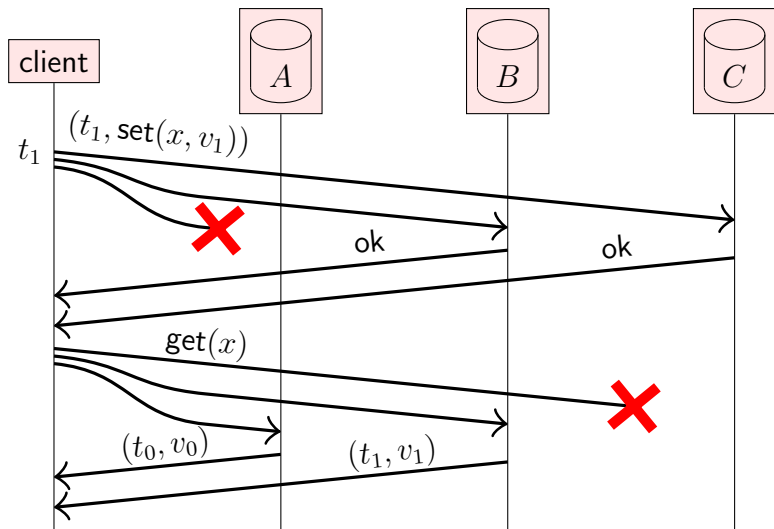

Write succeeds on  $B$  and  $C$ ; read succeeds on  $A$  and  $B$   
Choose between  $(t_0, v_0)$  and  $(t_1, v_1)$  based on timestamp

# Read and write quorums

In a system with  $n$  replicas:

- ▶ If a write is acknowledged by  $w$  replicas (**write quorum**),
- ▶ and we subsequently read from  $r$  replicas (**read quorum**),
- ▶ and  $r + w > n$ ,
- ▶ ... then the read will see the previously written value (or a value that subsequently overwrote it)
- ▶ Read quorum and write quorum share  $\geq 1$  replica
- ▶ Typical:  $r = w = \frac{n+1}{2}$  for  $n = 3, 5, 7, \dots$  (majority)
- ▶ Reads can tolerate  $n - r$  unavailable replicas, writes  $n - w$

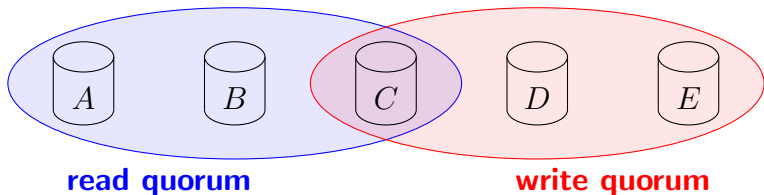

## Read repair

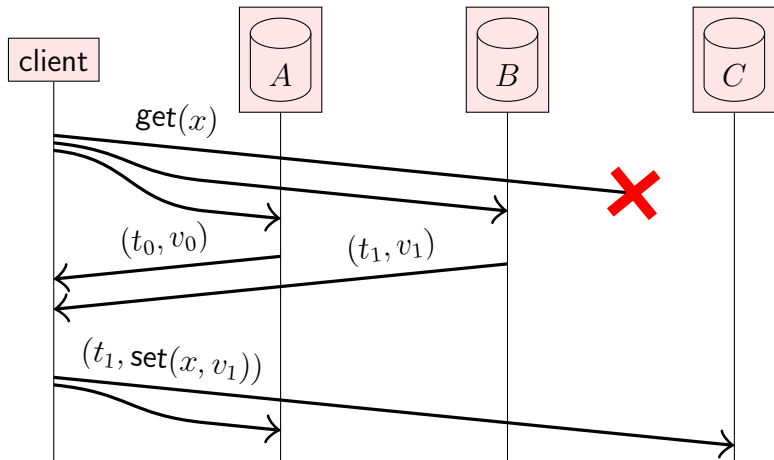

Update  $(t_1, v_1)$  is more recent than  $(t_0, v_0)$  since  $t_0 < t_1$ .  
Client helps **propagate**  $(t_1, v_1)$  to other replicas.

# State machine replication

So far we have used best-effort broadcast for replication.  
What about stronger broadcast models?

Total order broadcast: every node delivers the **same messages** in the **same order**

**State machine replication (SMR):**

- ▶ FIFO-total order broadcast every update to all replicas
- ▶ Replica delivers update message: apply it to own state
- ▶ Applying an update is deterministic
- ▶ Replica is a **state machine**: starts in fixed initial state, goes through same sequence of state transitions in the same order  $\implies$  all replicas end up in the same state

# State machine replication

**on** request to perform update  $u$  **do**  
    send  $u$  via FIFO-total order broadcast  
**end on**

**on** delivering  $u$  through FIFO-total order broadcast **do**  
    update state using arbitrary deterministic logic!  
**end on**

Closely related ideas:

- ▶ Serializable transactions (execute in delivery order)
- ▶ Blockchains, distributed ledgers, smart contracts

Limitations:

- ▶ Cannot update state immediately, have to wait for delivery through broadcast
- ▶ Need fault-tolerant total order broadcast: see lecture 6

# Database leader replica

Leader database replica  $L$  ensures total order broadcast

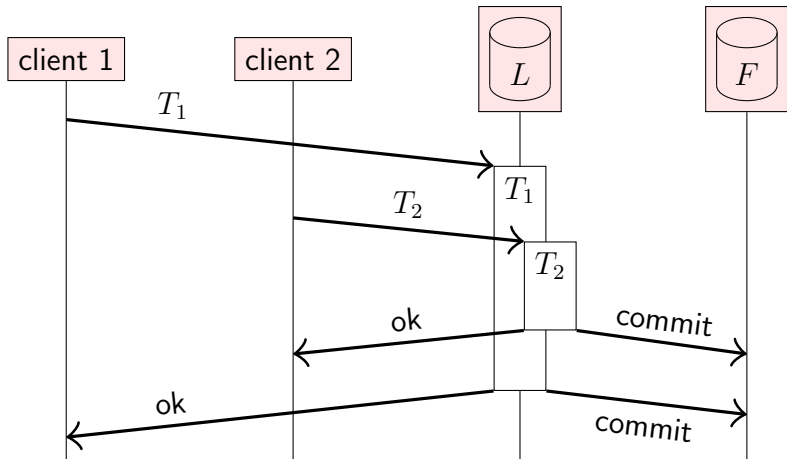

Follower  $F$  applies transaction log in commit order

# Replication using causal (and weaker) broadcast

State machine replication uses (FIFO-)total order broadcast.  
Can we use weaker forms of broadcast too?

If replica state updates are **commutative**, replicas can process updates in different orders and still end up in the same state.

Updates  $f$  and  $g$  are commutative if  $f(g(x)) = g(f(x))$

<b>broadcast</b>	<b>assumptions about state update function</b>
total order	deterministic (SMR)
causal	deterministic, concurrent updates commute
reliable	deterministic, all updates commute
best-effort	deterministic, commutative, idempotent, tolerates message loss

Lecture 6

# Consensus



# Fault-tolerant total order broadcast

Total order broadcast is very useful for state machine replication.

Can implement total order broadcast by sending all messages via a single **leader**.

Problem: what if leader crashes/becomes unavailable?

- ▶ **Manual failover**: a human operator chooses a new leader, and reconfigures each node to use new leader

Used in many databases! Fine for planned maintenance.

Unplanned outage? Humans are slow, may take a long time until system recovers. . .

- ▶ Can we **automatically choose a new leader**?

# Consensus and total order broadcast

- ▶ Traditional formulation of consensus: several nodes want to come to **agreement** about a single **value**
- ▶ In context of total order broadcast: this value is the **next message to deliver**
- ▶ Once one node **decides** on a certain message order, all nodes will decide the same order
- ▶ Consensus and total order broadcast are formally equivalent

Common consensus algorithms:

- ▶ **Paxos**: single-value consensus  
**Multi-Paxos**: generalisation to total order broadcast
- ▶ **Raft, Viewstamped Replication, Zab**:  
FIFO-total order broadcast by default

# Consensus system models

Paxos, Raft, etc. assume a **partially synchronous, crash-recovery** system model.

Why not asynchronous?

- ▶ **FLP result** (Fischer, Lynch, Paterson):  
There is no deterministic consensus algorithm that is guaranteed to terminate in an asynchronous crash-stop system model.
- ▶ Paxos, Raft, etc. use clocks only used for timeouts/failure detector to ensure progress. Safety (correctness) does not depend on timing.

There are also consensus algorithms for a partially synchronous **Byzantine** system model (used in blockchains)

# Leader election

Multi-Paxos, Raft, etc. use a leader to sequence messages.

- ▶ Use a **failure detector** (timeout) to determine suspected crash or unavailability of leader.
- ▶ On suspected leader crash, **elect a new one**.
- ▶ Prevent **two leaders at the same time** (“split-brain”)!

Ensure  $\leq 1$  leader per **term**:

- ▶ Term is incremented every time a leader election is started
- ▶ A node can only **vote once** per term
- ▶ Require a **quorum** of nodes to elect a leader in a term

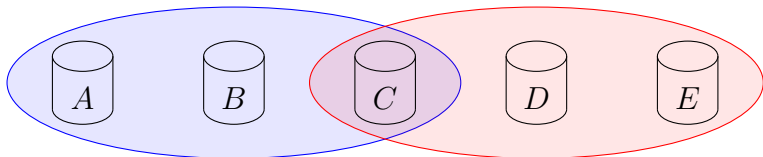

**elects a leader**

**cannot elect a different leader**  
because *C* already voted

# Can we guarantee there is only one leader?

Can guarantee unique leader **per term**.

**Cannot** prevent having multiple leaders from different terms.

Example: node 1 is leader in term  $t$ , but due to a network partition it can no longer communicate with nodes 2 and 3:

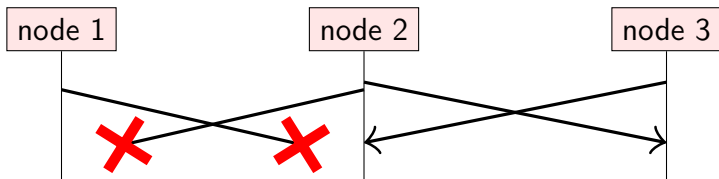

Nodes 2 and 3 may elect a new leader in term  $t + 1$ .

Node 1 may not even know that a new leader has been elected!

# Checking if a leader has been voted out

For every decision (message to deliver), the leader must first get acknowledgements from a quorum.

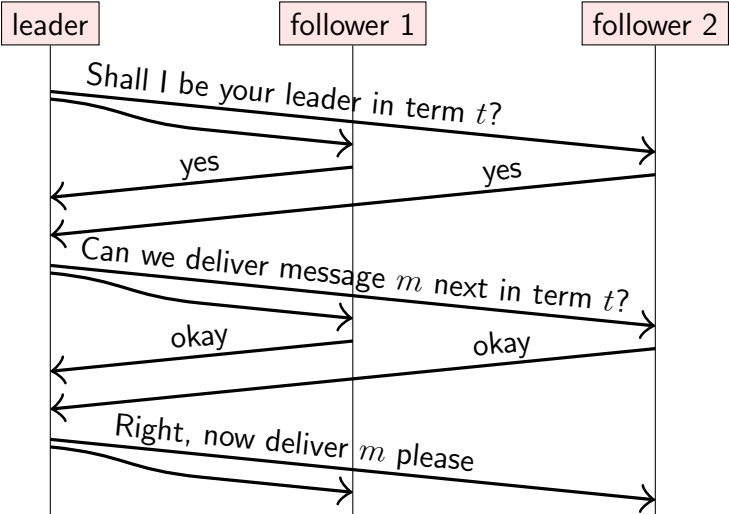

# Node state transitions in Raft

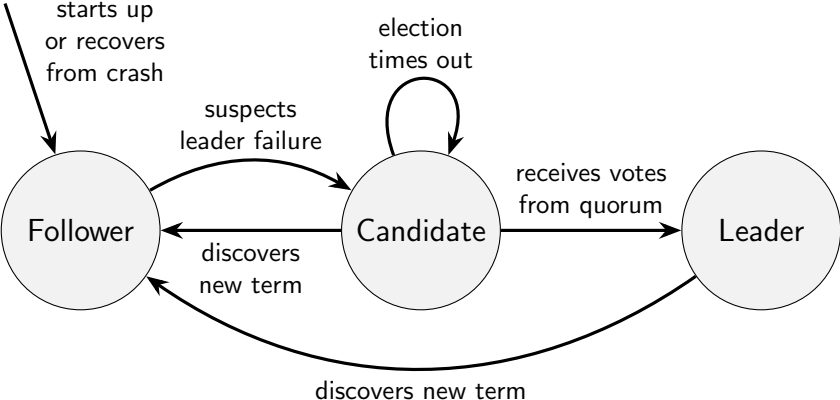

# Raft (1/9): initialisation

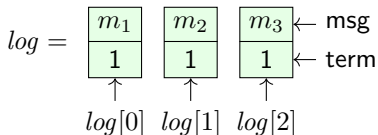

**on** initialisation **do**

$currentTerm := 0$ ;  $votedFor := null$

$log := \langle \rangle$ ;  $commitLength := 0$

$currentRole := follower$ ;  $currentLeader := null$

$votesReceived := \{ \}$ ;  $sentLength := \langle \rangle$ ;  $ackedLength := \langle \rangle$

**end on**

**on** recovery from crash **do**

$currentRole := follower$ ;  $currentLeader := null$

$votesReceived := \{ \}$ ;  $sentLength := \langle \rangle$ ;  $ackedLength := \langle \rangle$

**end on**

**on** node  $nodeId$  suspects leader has failed, or on election timeout **do**

$currentTerm := currentTerm + 1$ ;  $currentRole := candidate$

$votedFor := nodeId$ ;  $votesReceived := \{ nodeId \}$ ;  $lastTerm := 0$

**if**  $log.length > 0$  **then**  $lastTerm := log[log.length - 1].term$ ; **end if**

$msg := (VoteRequest, nodeId, currentTerm, log.length, lastTerm)$

**for each**  $node \in nodes$ : **send**  $msg$  to  $node$

start election timer

**end on**



## Raft (2/9): voting on a new leader



*c* for candidate

**on** receiving (VoteRequest, *cId*, *cTerm*, *cLogLength*, *cLogTerm*)  
at node *nodeId* **do**

*myLogTerm* := *log*[*log.length* - 1].*term*

*logOk* := (*cLogTerm* > *myLogTerm*) ∨

(*cLogTerm* = *myLogTerm* ∧ *cLogLength* ≥ *log.length*)

*termOk* := (*cTerm* > *currentTerm*) ∨

(*cTerm* = *currentTerm* ∧ *votedFor* ∈ {*cId*, null})

**if** *logOk* ∧ *termOk* **then**

*currentTerm* := *cTerm*

*currentRole* := follower

*votedFor* := *cId*

**send** (VoteResponse, *nodeId*, *currentTerm*, true) to node *cId*

**else**

**send** (VoteResponse, *nodeId*, *currentTerm*, false) to node *cId*

**end if**

**end on**

## Raft (3/9): collecting votes

```
on receiving (VoteResponse, voterId, term, granted) at nodeId do  
  if currentRole = candidate  $\wedge$  term = currentTerm  $\wedge$  granted then  
    votesReceived := votesReceived  $\cup$  {voterId}  
    if |votesReceived|  $\geq$   $\lceil (|nodes| + 1)/2 \rceil$  then  
      currentRole := leader; currentLeader := nodeId  
      cancel election timer  
      for each follower  $\in$  nodes  $\setminus$  {nodeId} do  
        sentLength[follower] := log.length  
        ackedLength[follower] := 0  
        REPLICATELOG(nodeId, follower)  
      end for  
    end if  
  else if term > currentTerm then  
    currentTerm := term  
    currentRole := follower  
    votedFor := null  
    cancel election timer  
  end if  
end on
```

## Raft (4/9): broadcasting messages

```
on request to broadcast msg at node nodeId do  
  if currentRole = leader then  
    append the record (msg : msg, term : currentTerm) to log  
    ackedLength[nodeId] := log.length  
    for each follower ∈ nodes \ {nodeId} do  
      REPLICATELOG(nodeId, follower)  
    end for  
  else  
    forward the request to currentLeader via a FIFO link  
  end if  
end on
```

```
periodically at node nodeId do  
  if currentRole = leader then  
    for each follower ∈ nodes \ {nodeId} do  
      REPLICATELOG(nodeId, follower)  
    end for  
  end if  
end do
```

## Raft (5/9): replicating from leader to followers

Called on the leader whenever there is a new message in the log, and also periodically. If there are no new messages, *entries* is the empty list. LogRequest messages with *entries* =  $\langle \rangle$  serve as heartbeats, letting followers know that the leader is still alive.

```
function REPLICATELOG(leaderId, followerId)
  i := sentLength[followerId]
  entries :=  $\langle \log[i], \log[i + 1], \dots, \log[\log.length - 1] \rangle$ 
  prevLogTerm := 0
  if i > 0 then
    prevLogTerm :=  $\log[i - 1].term$ 
  end if
  send (LogRequest, leaderId, currentTerm, i, prevLogTerm,
    commitLength, entries) to followerId
end function
```

## Raft (6/9): followers receiving messages

```
on receiving (LogRequest, leaderId, term, logLength, logTerm,  
             leaderCommit, entries) at node nodeId do  
  if term > currentTerm then  
    currentTerm := term; votedFor := null  
  end if  
  logOk := (log.length ≥ logLength)  
  if logOk ∧ (logLength > 0) then  
    logOk := (logTerm = log[logLength - 1].term)  
  end if  
  
  if term = currentTerm ∧ logOk then  
    currentRole := follower; currentLeader := leaderId  
    APPENDENTRIES(logLength, leaderCommit, entries)  
    ack := logLength + entries.length  
    send (LogResponse, nodeId, currentTerm, ack, true) to leaderId  
  else  
    send (LogResponse, nodeId, currentTerm, 0, false) to leaderId  
  end if  
end on
```

## Raft (7/9): updating followers' logs

```
function APPENDETRIES(logLength, leaderCommit, entries)  
  if entries.length > 0  $\wedge$  log.length > logLength then  
    if log[logLength].term  $\neq$  entries[0].term then  
      log :=  $\langle$ log[0], log[1], ..., log[logLength - 1] $\rangle$   
    end if  
  end if  
  
  if logLength + entries.length > log.length then  
    for i := log.length - logLength to entries.length - 1 do  
      append entries[i] to log  
    end for  
  end if  
  
  if leaderCommit > commitLength then  
    for i := commitLength to leaderCommit - 1 do  
      deliver log[i].msg to the application  
    end for  
    commitLength := leaderCommit  
  end if  
end function
```

## Raft (8/9): leader receiving log acknowledgements

```
on receiving (LogResponse, follower, term, ack, success) at nodeId do  
  if term = currentTerm  $\wedge$  currentRole = leader then  
    if success = true  $\wedge$  ack  $\geq$  ackedLength[follower] then  
      sentLength[follower] := ack  
      ackedLength[follower] := ack  
      COMMITLOGENTRIES()  
    else if sentLength[follower] > 0 then  
      sentLength[follower] := sentLength[follower] - 1  
      REPLICATELOG(nodeId, follower)  
    end if  
  else if term > currentTerm then  
    currentTerm := term  
    currentRole := follower  
    votedFor := null  
  end if  
end on
```

## Raft (9/9): leader committing log entries

Any log entries that have been acknowledged by a quorum of nodes are ready to be committed by the leader. When a log entry is committed, its message is delivered to the application.

**define**  $\text{acks}(length) = |\{n \in \text{nodes} \mid \text{ackedLength}[n] \geq length\}|$

**function** COMMITLOGENTRIES

$\text{minAcks} := \lceil (|\text{nodes}| + 1)/2 \rceil$

$\text{ready} := \{len \in \{1, \dots, \text{log.length}\} \mid \text{acks}(len) \geq \text{minAcks}\}$

**if**  $\text{ready} \neq \{\}$   $\wedge \max(\text{ready}) > \text{commitLength} \wedge$   
 $\text{log}[\max(\text{ready}) - 1].\text{term} = \text{currentTerm}$  **then**

**for**  $i := \text{commitLength}$  **to**  $\max(\text{ready}) - 1$  **do**

    deliver  $\text{log}[i].\text{msg}$  to the application

**end for**

$\text{commitLength} := \max(\text{ready})$

**end if**

**end function**



## Lecture 7

# Replica consistency

# “Consistency”

A word that means many different things in different contexts!

- ▶ **ACID**: a transaction transforms the database from one “consistent” state to another

Here, “consistent” = satisfying application-specific invariants

e.g. “every course with students enrolled must have at least one lecturer”

- ▶ **Read-after-write consistency** (lecture 5)
- ▶ **Replication**: replica should be “consistent” with other replicas

“consistent” = in the same state? (when exactly?)

“consistent” = read operations return same result?

- ▶ **Consistency model**: many to choose from

# Distributed transactions

Recall **atomicity** in the context of ACID transactions:

- ▶ A transaction either **commits** or **aborts**
- ▶ If it commits, its updates are durable
- ▶ If it aborts, it has no visible side-effects
- ▶ ACID consistency (preserving invariants) relies on atomicity

If the transaction updates data on multiple nodes, this implies:

- ▶ Either all nodes must commit, or all must abort
- ▶ If any node crashes, all must abort

Ensuring this is the **atomic commitment** problem.

Looks a bit similar to consensus?

# Atomic commit versus consensus

<b>Consensus</b>	<b>Atomic commit</b>
One or more nodes propose a value	Every node votes whether to commit or abort
Any one of the proposed values is decided	Must commit if all nodes vote to commit; must abort if $\geq 1$ nodes vote to abort
Crashed nodes can be tolerated, as long as a quorum is working	Must abort if a participating node crashes

# Two-phase commit (2PC)

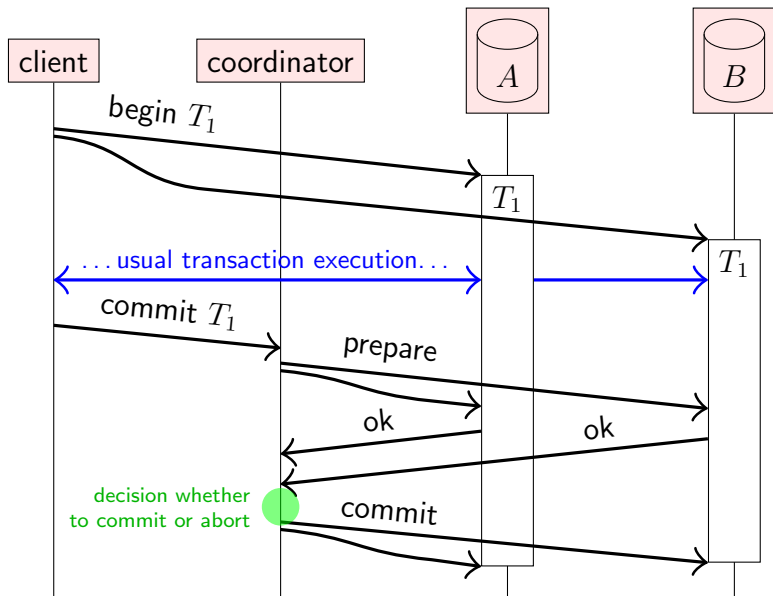

# The coordinator in two-phase commit

What if the coordinator crashes?

- ▶ Coordinator writes its decision to disk
- ▶ When it recovers, read decision from disk and send it to replicas (or abort if no decision was made before crash)
- ▶ **Problem:** if coordinator crashes after prepare, but before broadcasting decision, other nodes do not know how it has decided
- ▶ Replicas participating in transaction cannot commit or abort after responding “ok” to the *prepare* request (otherwise we risk violating atomicity)
- ▶ Algorithm is blocked until coordinator recovers

## Fault-tolerant two-phase commit (1/2)

**on** initialisation for transaction  $T$  **do**

$commitVotes[T] := \{\}; replicas[T] := \{\}; decided[T] := false$

**end on**

**on** request to commit transaction  $T$  with participating nodes  $R$  **do**

**for each**  $r \in R$  **do** send (Prepare,  $T$ ,  $R$ ) to  $r$

**end on**

**on** receiving (Prepare,  $T$ ,  $R$ ) at node  $replicaId$  **do**

$replicas[T] := R$

$ok =$  "is transaction  $T$  able to commit on this replica?"

total order broadcast (Vote,  $T$ ,  $replicaId$ ,  $ok$ ) to  $replicas[T]$

**end on**

**on** a node suspects node  $replicaId$  to have crashed **do**

**for each** transaction  $T$  in which  $replicaId$  participated **do**

total order broadcast (Vote,  $T$ ,  $replicaId$ , false) to  $replicas[T]$

**end for**

**end on**

## Fault-tolerant two-phase commit (2/2)

```
on delivering (Vote, T, replicaId, ok) by total order broadcast do  
  if  $replicaId \notin commitVotes[T] \wedge replicaId \in replicas[T] \wedge$   
     $\neg decided[T]$  then  
    if ok = true then  
       $commitVotes[T] := commitVotes[T] \cup \{replicaId\}$   
      if  $commitVotes[T] = replicas[T]$  then  
         $decided[T] := true$   
        commit transaction T at this node  
      end if  
    else  
       $decided[T] := true$   
      abort transaction T at this node  
    end if  
  end if  
end on
```



# Linearizability

Multiple nodes concurrently accessing replicated data.  
How do we define “consistency” here?

The strongest option: **linearizability**

- ▶ Informally: every operation takes effect **atomically** sometime after it started and before it finished
- ▶ All operations behave as if executed on a **single copy** of the data (even if there are in fact multiple replicas)
- ▶ Consequence: every operation returns an “up-to-date” value, a.k.a. “strong consistency”
- ▶ Not just in distributed systems, also in shared-memory concurrency (memory on multi-core CPUs is not linearizable by default!)

Note: linearizability  $\neq$  serializability!

# Read-after-write consistency revisited

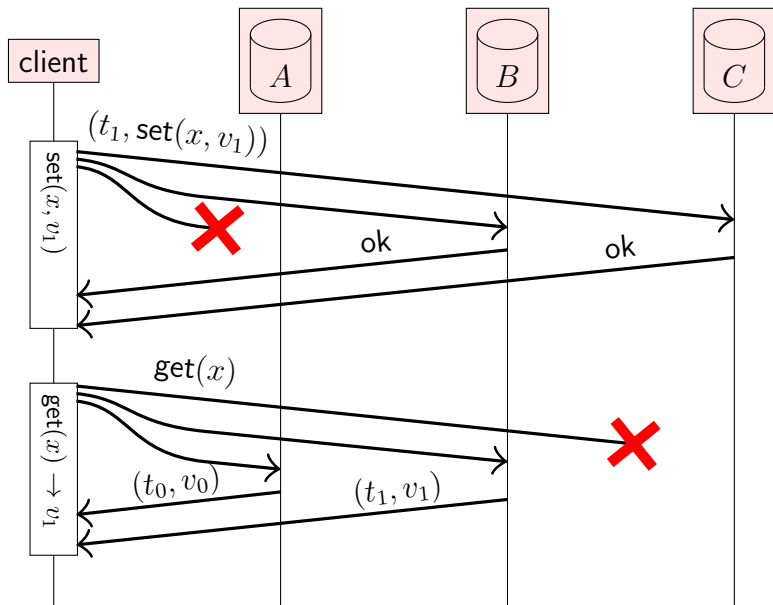

## From the client's point of view

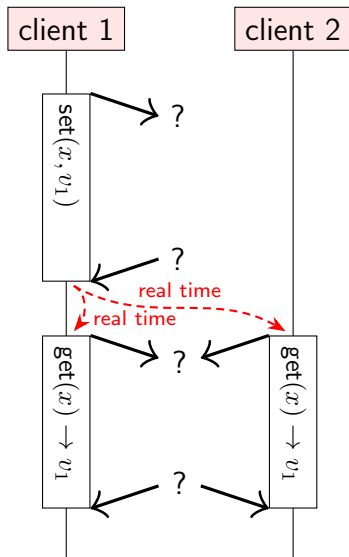

- ▶ Focus on client-observable behaviour: when and what an operation returns
- ▶ Ignore how the replication system is implemented internally
- ▶ Did operation *A* finish before operation *B* started?
- ▶ Even if the operations are on different nodes?
- ▶ **This is not happens-before:** we want client 2 to read value written by client 1, even if the clients have not communicated!

## Operations overlapping in time

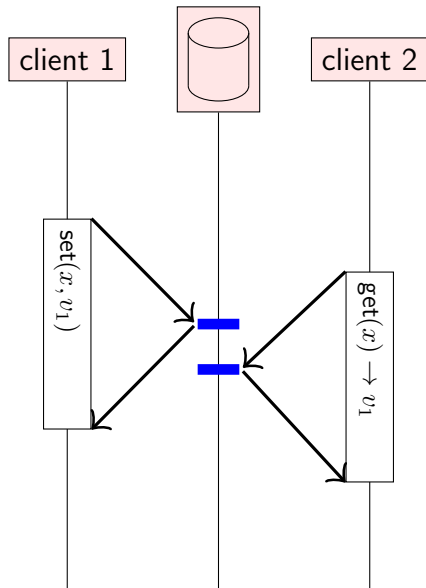

- ▶ Client 2's get operation overlaps in time with client 1's set operation
- ▶ Maybe the set operation takes effect first?
- ▶ Just as likely, the get operation may be executed first
- ▶ Either outcome is fine in this case

# Not linearizable, despite quorum reads/writes

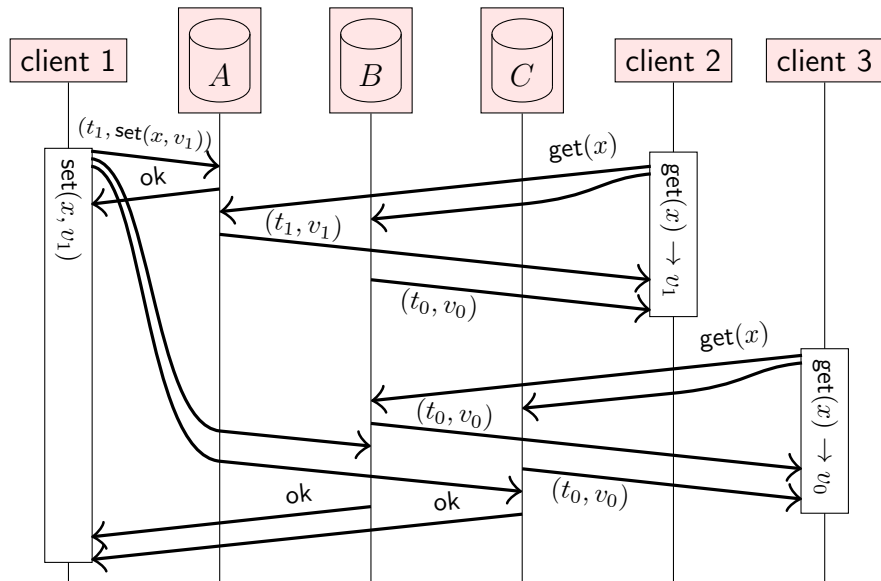

# Not linearizable, despite quorum reads/writes

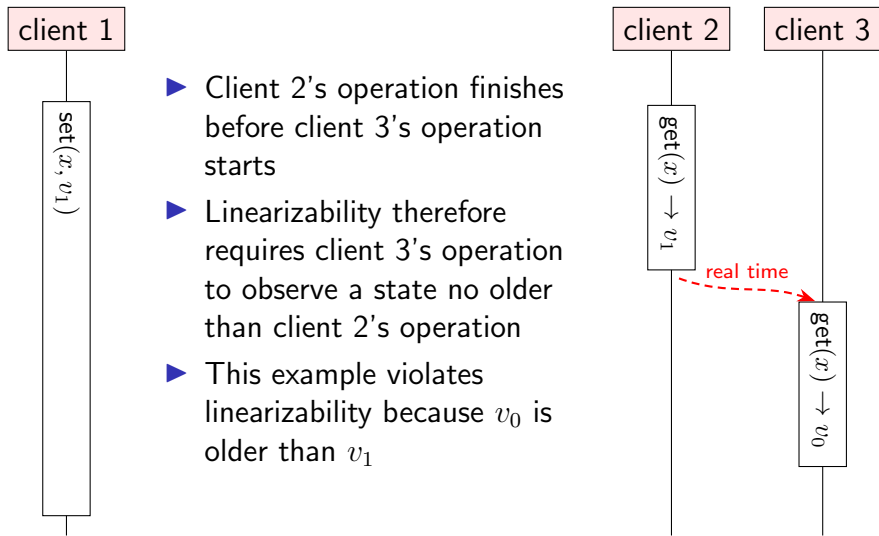

# Making quorum reads/writes linearizable

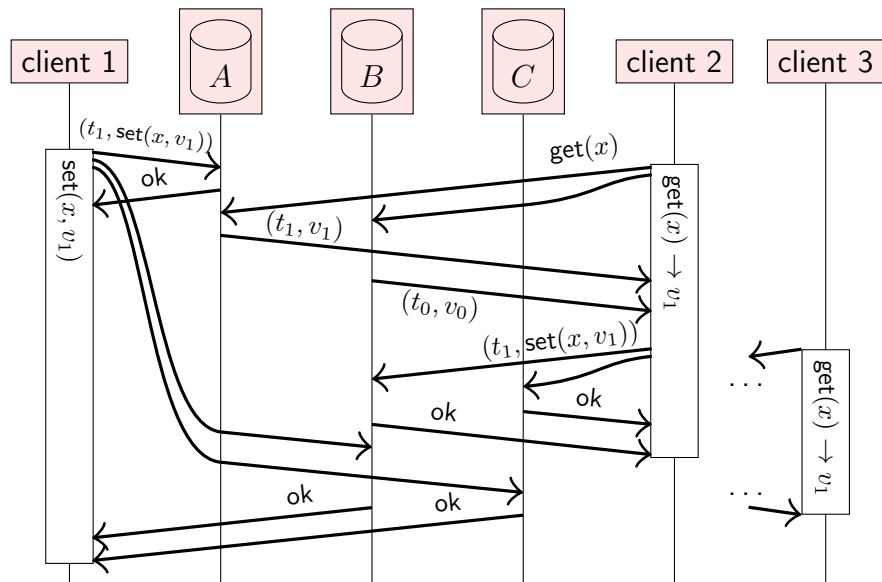

# Linearizability for different types of operation

This ensures linearizability of get (quorum read) and set (**blind write** to quorum)

- ▶ When an operation finishes, the value read/written is stored on a quorum of replicas
- ▶ Every subsequent quorum operation will see that value
- ▶ Multiple concurrent writes may overwrite each other

What about an atomic **compare-and-swap** operation?

- ▶  $CAS(x, oldValue, newValue)$  sets  $x$  to  $newValue$  iff current value of  $x$  is  $oldValue$
- ▶ Previously discussed in shared memory concurrency
- ▶ Can we implement **linearizable** compare-and-swap in a distributed system?
- ▶ **Yes:** total order broadcast to the rescue again!



# Linearizable compare-and-swap (CAS)

**on** request to perform  $\text{get}(x)$  **do**  
    total order broadcast ( $\text{get}, x$ ) and wait for delivery  
**end on**

**on** request to perform  $\text{CAS}(x, \text{old}, \text{new})$  **do**  
    total order broadcast ( $\text{CAS}, x, \text{old}, \text{new}$ ) and wait for delivery  
**end on**

**on** delivering ( $\text{get}, x$ ) by total order broadcast **do**  
    **return**  $\text{localState}[x]$  as result of operation  $\text{get}(x)$   
**end on**

**on** delivering ( $\text{CAS}, x, \text{old}, \text{new}$ ) by total order broadcast **do**  
     $\text{success} := \text{false}$   
    **if**  $\text{localState}[x] = \text{old}$  **then**  
         $\text{localState}[x] := \text{new}; \text{success} := \text{true}$   
    **end if**  
    **return**  $\text{success}$  as result of operation  $\text{CAS}(x, \text{old}, \text{new})$   
**end on**

# Eventual consistency

Linearizability advantages:

- ▶ Makes a distributed system behave as if it were non-distributed
- ▶ Simple for applications to use

Downsides:

- ▶ **Performance** cost: lots of messages and waiting for responses
- ▶ **Scalability** limits: leader can be a bottleneck
- ▶ **Availability** problems: if you can't contact a quorum of nodes, you can't process any operations

**Eventual consistency**: a weaker model than linearizability.  
Different trade-off choices.

Calendars + Day Week Month Year United Kingdom Time Q Search

# 5 November 2020

Thursday

all-day

07:00

08:00

09:00

10:00

11:00

12:00

13:00

14:00

15:00

16:00

17:00

18:00

19:00

M	T	W	T	F	S	S
26	27	28	29	30	31	1
2	3	4	5	6	7	8
9	10	11	12	13	14	15
16	17	18	19	20	21	22
23	24	25	26	27	28	29
30	1	2	3	4	5	6

No Event Selected

12:00  
Distributed systems lecture

14:00  
Test

09:41 100%

< November

M	T	W	T	F	S	S
2	3	4	5	6	7	8

Thursday 5 November 2020

10:00

11:00

12:00

13:00

14:00

15:00

16:00

17:00

18:00

Distributed systems lecture

Test

Today Calendars Inbox

# The CAP theorem

A system can be either strongly **Consistent** (linearizable) or **Available** in the presence of a network **Partition**

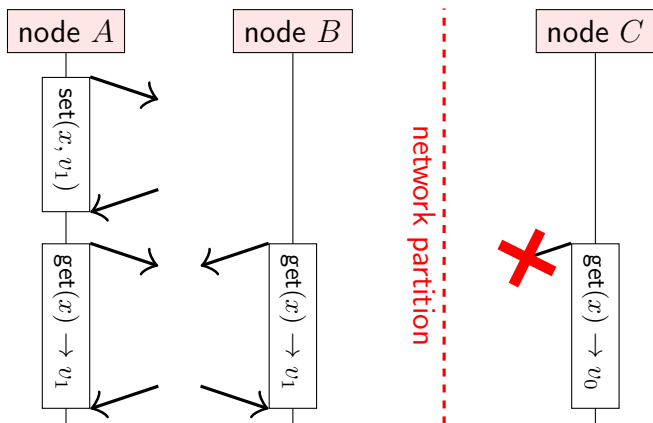

*C* must either wait indefinitely for the network to recover, or return a potentially stale value

# Eventual consistency

Replicas process operations based only on their local state.

If there are no more updates, **eventually** all replicas will be in the same state. (No guarantees how long it might take.)

## Strong eventual consistency:

- ▶ **Eventual delivery:** every update made to one non-faulty replica is eventually processed by every non-faulty replica.
- ▶ **Convergence:** any two replicas that have processed the same set of updates are in the same state (even if updates were processed in a different order).

## Properties:

- ▶ Does not require waiting for network communication
- ▶ Causal broadcast (or weaker) can disseminate updates
- ▶ Concurrent updates  $\implies$  **conflicts** need to be resolved

# Summary of minimum system model requirements

<b>Problem</b>	<b>Must wait for communication</b>	<b>Requires synchrony</b>
atomic commit	all participating nodes	partially synchronous
consensus, total order broadcast, linearizable CAS	quorum	partially synchronous
linearizable get/set	quorum	asynchronous
eventual consistency, causal broadcast, FIFO broadcast	local replica only	asynchronous



strength of assumptions

## Lecture 8

# Concurrency control in applications

# Collaboration and conflict resolution

Nowadays we use a lot of **collaboration software**:

- ▶ **Examples:** calendar sync (last lecture), Google Docs, ...
- ▶ Several users/devices working on a shared file/document
- ▶ Each user device has local replica of the data
- ▶ Update local replica anytime (even while offline), sync with others when network available
- ▶ **Challenge:** how to reconcile concurrent updates?

Families of **algorithms**:

- ▶ Conflict-free Replicated Data Types (**CRDTs**)
  - ▶ Operation-based
  - ▶ State-based
- ▶ Operational Transformation (**OT**)



# Conflicts due to concurrent updates

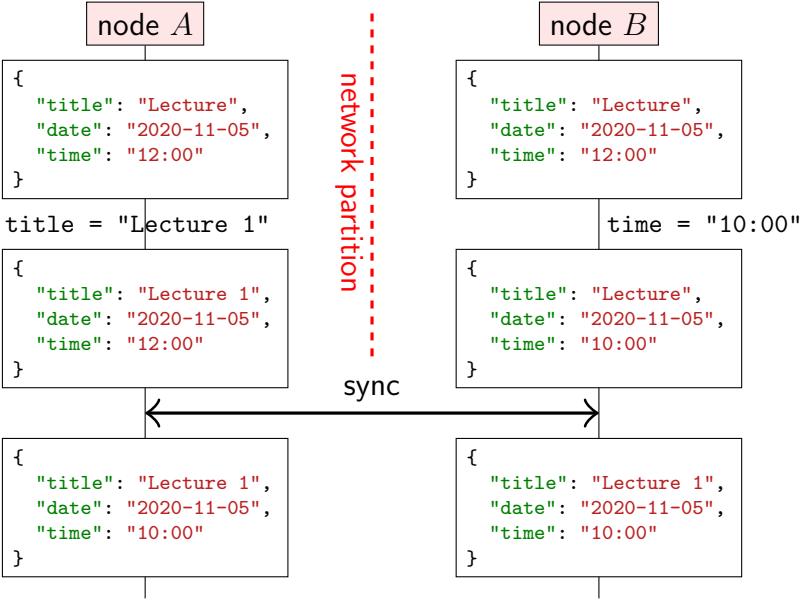

# Operation-based map CRDT

**on** initialisation **do**

$values := \{\}$

**end on**

**on** request to read value for key  $k$  **do**

**if**  $\exists t, v. (t, k, v) \in values$  **then return**  $v$  **else return** null

**end on**

**on** request to set key  $k$  to value  $v$  **do**

$t := \text{newTimestamp}()$   $\triangleright$  globally unique, e.g. Lamport timestamp

**broadcast**  $(\text{set}, t, k, v)$  by reliable broadcast (including to self)

**end on**

**on** delivering  $(\text{set}, t, k, v)$  by reliable broadcast **do**

$previous := \{(t', k', v') \in values \mid k' = k\}$

**if**  $previous = \{\} \vee \forall (t', k', v') \in previous. t' < t$  **then**

$values := (values \setminus previous) \cup \{(t, k, v)\}$

**end if**

**end on**

## Operation-based CRDTs

Reliable broadcast may deliver updates in any order:

- ▶ broadcast (set,  $t_1$ , "title", "Lecture 1")
- ▶ broadcast (set,  $t_2$ , "time", "10:00")

Recall **strong eventual consistency**:

- ▶ **Eventual delivery**: every update made to one non-faulty replica is eventually processed by every non-faulty replica.
- ▶ **Convergence**: any two replicas that have processed the same set of updates are in the same state

CRDT algorithm implements this:

- ▶ Reliable broadcast ensures every operation is eventually delivered to every (non-crashed) replica
- ▶ Applying an operation is **commutative**: order of delivery doesn't matter

# State-based map CRDT

The operator  $\sqcup$  merges two states  $s_1$  and  $s_2$  as follows:

$$s_1 \sqcup s_2 = \{(t, k, v) \in (s_1 \cup s_2) \mid \nexists (t', k', v') \in (s_1 \cup s_2). k' = k \wedge t' > t\}$$

**on** initialisation **do**

*values* := {}

**end on**

**on** request to read value for key  $k$  **do**

**if**  $\exists t, v. (t, k, v) \in \textit{values}$  **then return**  $v$  **else return** null

**end on**

**on** request to set key  $k$  to value  $v$  **do**

$t := \text{newTimestamp}()$   $\triangleright$  globally unique, e.g. Lamport timestamp

*values* :=  $\{(t', k', v') \in \textit{values} \mid k' \neq k\} \cup \{(t, k, v)\}$

**broadcast** *values* by best-effort broadcast

**end on**

**on** delivering  $V$  by best-effort broadcast **do**

*values* := *values*  $\sqcup$   $V$

**end on**

# State-based CRDTs

Merge operator  $\sqcup$  must satisfy:  $\forall s_1, s_2, s_3 \dots$

- ▶ **Commutative:**  $s_1 \sqcup s_2 = s_2 \sqcup s_1$ .
- ▶ **Associative:**  $(s_1 \sqcup s_2) \sqcup s_3 = s_1 \sqcup (s_2 \sqcup s_3)$ .
- ▶ **Idempotent:**  $s_1 \sqcup s_1 = s_1$ .

State-based versus operation-based:

- ▶ Op-based CRDT typically has smaller messages
- ▶ State-based CRDT can tolerate message loss/duplication

Not necessarily uses broadcast:

- ▶ Can also merge concurrent updates to replicas e.g. in quorum replication, anti-entropy, ...

This screenshot shows a browser window with a single tab titled "Test document - Google Docs". The address bar contains the URL "docs.google.com/document/d/1C6\_8\_oNcInbM9gfaaldIZuvGTPrVGeq8v9munZCnyd...". The document title is "Test document". The menu bar includes "File", "Edit", "View", "Insert", "Format", "Tools", "Add-ons", and "Help". The status bar indicates "Last edit was 15 min...". The toolbar shows a zoom level of 100%, "Normal text" style, and "Arial" font. The main content area contains the text "One Two Three". A blue "Share" button is visible in the top right corner.

This screenshot is identical to the one above, showing a browser window with a single tab titled "Test document - Google Docs". The address bar contains the URL "docs.google.com/document/d/1C6\_8\_oNcInbM9gfaaldIZuvGTPrVGeq8v9munZCnyd...". The document title is "Test document". The menu bar includes "File", "Edit", "View", "Insert", "Format", "Tools", "Add-ons", and "Help". The status bar indicates "Last edit was 15 min...". The toolbar shows a zoom level of 100%, "Normal text" style, and "Arial" font. The main content area contains the text "One Two Three". A blue "Share" button is visible in the top right corner.

# Collaborative text editing: the problem

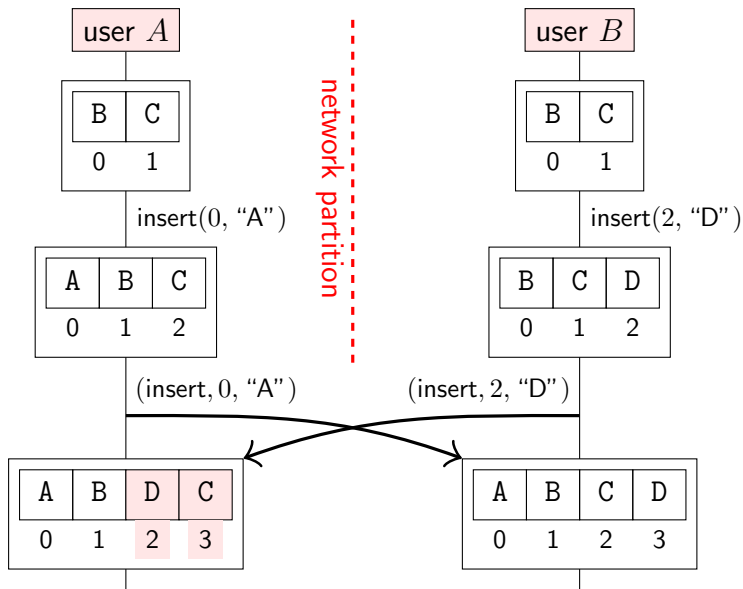

# Operational transformation

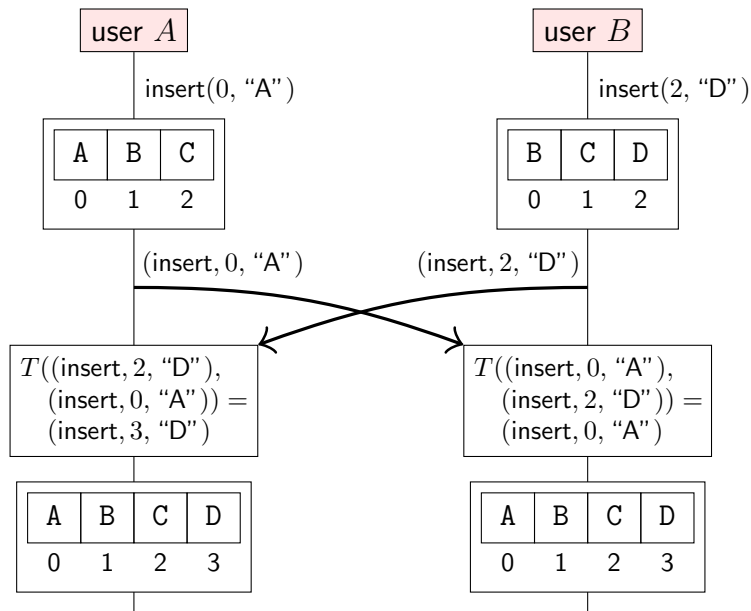



# Text editing CRDT

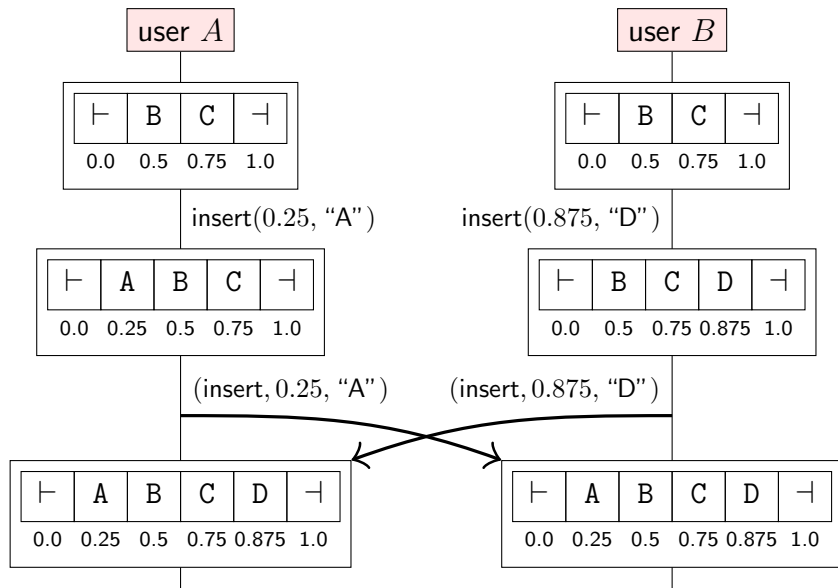

## Operation-based text CRDT (1/2)

**function** ELEMENTAT(*chars*, *index*)

*min* = the unique triple  $(p, n, v) \in \text{chars}$  such that

$\nexists (p', n', v') \in \text{chars}. p' < p \vee (p' = p \wedge n' < n)$

**if** *index* = 0 **then return** *min*

**else return** ELEMENTAT(*chars* \ {*min*}, *index* - 1)

**end function**

**on** initialisation **do**

*chars* := {(0, null,  $\vdash$ ), (1, null,  $\dashv$ )}

**end on**

**on** request to read character at index *index* **do**

**let**  $(p, n, v) := \text{ELEMENTAT}(\text{chars}, \text{index} + 1)$ ; **return** *v*

**end on**

**on** request to insert character *v* at index *index* at node *nodeId* **do**

**let**  $(p_1, n_1, v_1) := \text{ELEMENTAT}(\text{chars}, \text{index})$

**let**  $(p_2, n_2, v_2) := \text{ELEMENTAT}(\text{chars}, \text{index} + 1)$

**broadcast** (insert,  $(p_1 + p_2)/2$ , *nodeId*, *v*) by causal broadcast

**end on**

## Operation-based text CRDT (2/2)

**on** delivering (insert,  $p, n, v$ ) by causal broadcast **do**  
     $chars := chars \cup \{(p, n, v)\}$   
**end on**

**on** request to delete character at index  $index$  **do**  
    **let**  $(p, n, v) := \text{ELEMENTAT}(chars, index + 1)$   
    **broadcast** (delete,  $p, n$ ) by causal broadcast  
**end on**

**on** delivering (delete,  $p, n$ ) by causal broadcast **do**  
     $chars := \{(p', n', v') \in chars \mid \neg(p' = p \wedge n' = n)\}$   
**end on**

- ▶ Use causal broadcast so that insertion of a character is delivered before its deletion
- ▶ Insertion and deletion of different characters commute

# Google's Spanner

A database system with millions of nodes, petabytes of data, distributed across datacenters worldwide

Consistency properties:

- ▶ **Serializable** transaction isolation
- ▶ **Linearizable** reads and writes
- ▶ Many **shards**, each holding a subset of the data; atomic commit of transactions across shards

Many standard techniques:

- ▶ State machine replication (Paxos) within a shard
- ▶ Two-phase locking for serializability
- ▶ Two-phase commit for cross-shard atomicity

The interesting bit: read-only transactions require **no locks!**

## Consistent snapshots

A read-only transaction observes a **consistent snapshot**:

If  $T_1 \rightarrow T_2$  (e.g.  $T_2$  reads data written by  $T_1$ )...

- ▶ Snapshot reflecting writes by  $T_2$  also reflects writes by  $T_1$
- ▶ Snapshot that does not reflect writes by  $T_1$  does not reflect writes by  $T_2$  either
- ▶ In other words, snapshot is **consistent with causality**
- ▶ Even if read-only transaction runs for a long time

Approach: **multi-version concurrency control (MVCC)**

- ▶ Each read-write transaction  $T_w$  has commit timestamp  $t_w$
- ▶ Every value is tagged with timestamp  $t_w$  of transaction that wrote it (not overwriting previous value)
- ▶ Read-only transaction  $T_r$  has snapshot timestamp  $t_r$
- ▶  $T_r$  ignores values with  $t_w > t_r$ ; observes most recent value with  $t_w \leq t_r$

## Obtaining commit timestamps

Must ensure that whenever  $T_1 \rightarrow T_2$  we have  $t_1 < t_2$ .

- ▶ Physical clocks may be **inconsistent with causality**
- ▶ Can we use Lamport clocks instead?
- ▶ Problem: linearizability depends on **real-time order**, and logical clocks may not reflect this!

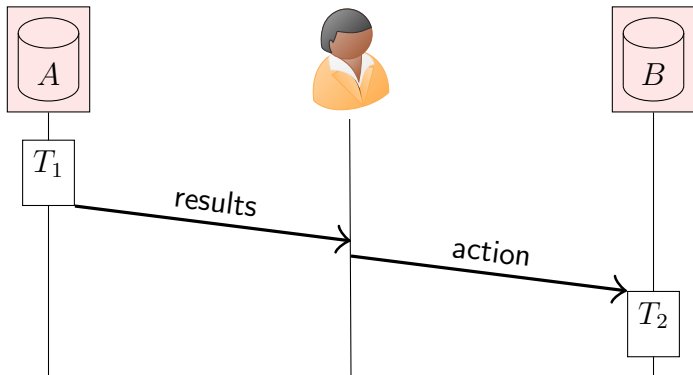

# TrueTime: explicit physical clock uncertainty

Spanner's TrueTime clock returns  $[t_{\text{earliest}}, t_{\text{latest}}]$ .

True physical timestamp must lie within that range.

On commit, wait for uncertainty  $\delta_i = t_{i,\text{latest}} - t_{i,\text{earliest}}$ .

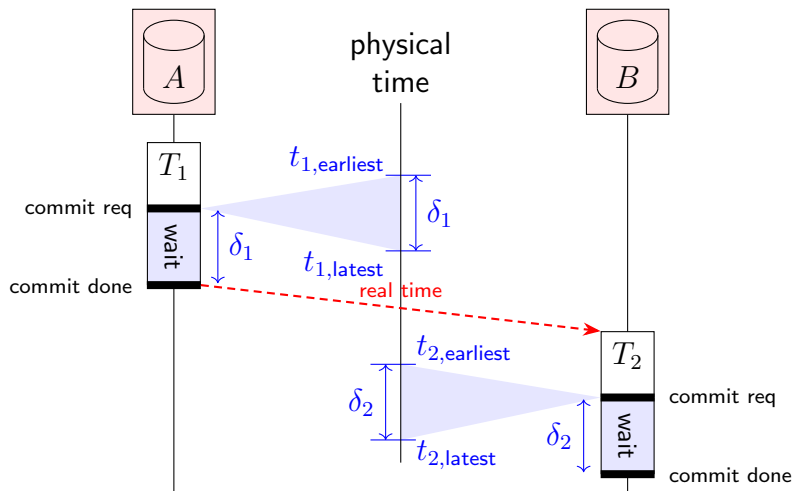

## Determining clock uncertainty in TrueTime

Clock servers with **atomic clock** or **GPS receiver** in each datacenter; servers report their clock uncertainty.  
Each node syncs its quartz clock with a server every 30 sec.  
Between syncs, assume worst-case drift of 200ppm.

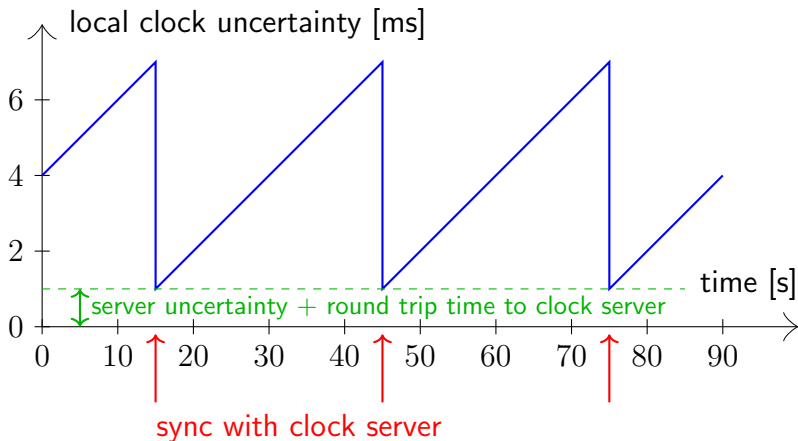



# That's all, folks!

**Any questions?** Email [mk428@cst.cam.ac.uk](mailto:mk428@cst.cam.ac.uk)!

Summary:

- ▶ Distributed systems are everywhere
- ▶ You use them every day: e.g. web apps
- ▶ Key goals: availability, scalability, performance
- ▶ Key problems: concurrency, faults, unbounded latency
- ▶ Key abstractions: replication, broadcast, consensus
- ▶ No one right way, just trade-offs